

VoIP Telephones

User: user
[Logout](#)

GAI-Tronics VoIP Help Point

[Home](#) [Configuration](#) [Status](#)

[Update](#) [Save](#) [Restore](#) [Reboot](#) [Help](#) [Advanced](#)

[Home](#)

VoIP Account 1 Information

voip account 1	
provider name	Ondo
user name	620
registration state	Registered

VoIP Account 2 Information

voip account 2	
provider name	Sark
user name	670
registration state	Not Registered

Configuration Guide:
Firmware versions:
1193 Telephones: **v1.08**
1201 Telephones (Auteldac 6): **v1.08**

VoIP Telephones

Configuration Guide

Firmware versions:

1193 Telephones: **v1.08**

1201 Telephones (Auteldac 6): **v1.08**

This guide applies to products containing the 999-02-1193-xxx main VoIP PCB (referred to as the "1193" PCB) and the 999-02-1201-xxx Auteldac 6 PCB (referred to as the "1201" PCB)

CONFIDENTIAL

The contents of this publication are confidential, are the property of GAI-Tronics, and may not be reproduced, wholly or in part, without their written permission.

TRADEMARKS and LICENCES

All product and brand names are trademarks of their respective owners. Software licences and notices are available on the GAI-Tronics website at www.hubbell.com/gai-tronics/en/voip-support

POLICY

The policy of GAI-Tronics is one of continual development and improvement of products and we reserve the right therefore to alter specifications without notice.

GAI-Tronics
Brunel Drive
Stretton Park
BURTON-UPON-TRENT
Staffordshire
England
DE13 0BZ

Tel.: +44 (0)1283 500500
Fax.: +44 (0)1283 500400
www.gai-tronics.com

Contents

1. Introduction	5
2. Models supported	6
3. How the product is intended to work	6
3.1 Operating Sequence	6
3.2 Dictionary of terms	7
4. Setting up and Configuring the Telephones	9
4.1 Web Page Structure	9
4.2 Quick Start	12
4.3 Web Page Controls	12
4.4 Configuration Parameter Descriptions	12
4.5 Code string explanations	55
4.5.1 Codecs	56
4.5.2 Button map string	56
4.5.3 Speed dial group array	58
4.5.4 LED / Relay map string	59
4.5.5 Call progress patterns and priorities	59
4.5.6 Input pattern	61
4.5.7 Fault mask codes	62
4.5.8 Ring Tones / Call Progress Tones	62
4.5.8.1 Suggested tone settings (UK)	63
4.5.8.2 Suggested tone settings (US)	63
4.5.8.3 Suggested tone settings (France)	64
4.5.8.4 Suggested tone settings (Netherlands)	64
4.5.8.5 Suggested tone settings (Portugal)	64
4.5.8.6 Suggested tone settings (Norway)	65
4.5.8.7 Parameters for specifying custom call progress tones	65
4.6 Status Page	66
4.6.1 System Status	66
4.6.1.1 General status	66
4.6.1.2 SIP status	66
4.6.2 Calls	66
5. Server Failover	66
6. Audio Path Testing (APT)	67
7. Features on the main 1193 PCB	68
7.1 Reset button	68
7.2 Factory Restore button	68
7.3 LEDs	69
7.4 USB connection	69
8. Remote update	69

GAI-TRONICS

8.1	Structure of files used in the update process	70
8.1.1	Update control file	70
8.1.2	Configuration file	70
8.1.3	Firmware and boot files	71
8.2	TFTP update process	71
8.2.1	TFTP Upgrade Example	72
9.	SNMP	74
9.1	General SNMP set up	74
9.2	Maintenance	75
9.3	SNMP Traps	75
10.	Fault reporting (via SNMP and / or FTP)	75
11.	TMA	76
12.	Restore to Factory defaults	77
13.	Copyright Notices	77

1. Introduction

This guide provides information on the operation and configuration of second generation GAI-Tronics rugged VoIP telephones containing the 999-02-1193-xxx main VoIP PCB (referred to as the "1193" PCB) or the 999-02-1201-xxx Auteldac 6 PCB (referred to as the "1201" PCB).

There are significant changes to the configuration commands and web pages from those in first generation products. Configuration guides for previous versions will remain available on the GAI-Tronics UK website (www.hubbell.com/gai-tronics/en/voip-support) as a reference for earlier versions.

GAI-Tronics VoIP telephones are available in a variety of model styles, including handset and hands-free models, but the programming and configuration methods are common to all.

Please note that the features may depend on the model type, and that therefore this guide may describe features not available on the particular model being configured.

Features of the GAI-Tronics range of VoIP telephones include:

- SIP compatible (RFC3261) only
- Registration with multiple SIP proxies
- Configurable via web pages, SNMP or by the telephone downloading a configuration file
- Outgoing cascading call lists
- Real-time alarm reporting via SNMP
- 4 auxiliary inputs, 2 volt-free contact outputs (except Auteldac 6, which has no inputs and only a single output).

This guide does not include information on:

- Installation, cabling and connections (see guide 502-20-0172-001 for Commander, Help Point or Titan products, or 502-20-0600-001 for Auteldac 6)
- Setting up, configuring and operating a network for VoIP. Please ensure that the network is configured to allow VoIP communications (using the SIP protocol) between the desired locations before attempting to configure GAI-Tronics telephones.

2. Models supported

This guide applies to products containing the 999-02-1193-xxx VoIP PCB or the 999-02-1201-xxx Auteldac 6 PCB

3. How the product is intended to work

The VoIP telephone has been designed to mimic the behaviour of a traditional, analogue telephone, specifically based on the GAI-Tronics range of rugged telephones, to give continuity where VoIP and analogue units are used in similar situations.

Accordingly, traditional telephone terminology is used throughout the manuals and documentation, and many of the features are designed to mimic analogue telephone behaviour.

A major difference between analogue telephones and VoIP is that, with analogue units, most signalling and tones such as ringing, dial tone, busy tone etc., are provided by a telephone exchange (PABX), whereas the VoIP unit must generate these itself. The telephone provides features to change the various tones to emulate those of different countries or PABXs, to give familiar operation in its intended location.

3.1 Operating Sequence.

Typical sequences of events for various model types are explained below:

Handset models (Titan, Commander, Auteldac 6)

Placing a call

- Lift handset (off hook) or press the headset on/off hook button if fitted (A6 only)
- Dial tone in receiver
- Dial number – either by:
 - Pressing a memory dial, in which case the call is initiated immediately, or
 - Pressing a sequence of digits, in which case the call is initiated when a termination digit is pressed (* or # by default, but see section 4.5.6), or if no digit is pressed for 5 seconds. A confidence tone is heard in the receiver for each digit pressed.
- Call progress tone in receiver (e.g. ring tone)
- Call is answered by remote party
- Normal voice call
- Replace handset (on hook) or press the headset on/off hook button if fitted (A6 only)
- Call terminates.

Receiving a call

- Telephone rings
- Lift handset (off hook) or press the headset on/off hook button if fitted (A6 only)
- Normal voice call
- Replace handset (on hook) or press the headset on/off hook button if fitted (A6 only)
- Call terminates.

Hands-free models (VR, Help Point, Sentinel and PHP400)

Placing a call

- Either
 - Press a memory dial button (wake and dial), or
 - Press an ON/OFF button (dial tone heard from speaker), followed by a sequence of digits, in which case the call is initiated when a termination digit is pressed (* or # by default, but see section 4.5.6), or if no digit is pressed for 5 seconds.
- Dialling confidence tones heard from speaker
- Call progress tone heard from speaker (e.g. ring tone)
- Call is answered by remote party
- Normal voice call

GAI-TRONICS

- Call terminates when the called party hangs up or if an ON/OFF button is pressed.

Receiving a call (with autoanswer OFF. See below for the behaviour when each different autoanswer mode is enabled)

- Ringing heard from speaker
- Press any memory dial button or an ON/OFF button to answer call
- Normal voice call
- Call terminates when the calling party hangs up or if an ON/OFF button is pressed

Autoanswer modes

- Preceding Tone
 - The telephone rings (using its default ring tone) before automatically starting a normal 2-way voice call.
 - The number of rings is set by the parameter `phone_autoanswer_ring_count`.
 - If the ring tone is continuous (ie has no OFF duration), the tone will play for a fixed period of time equal to `phone_autoanswer_ring_count` x 10ms.
- Silent Answer
 - The telephone will start a normal 2-way voice call immediately with no preceding tone.
- Babyphone Mode
 - The telephone will start a listen-only call immediately with no preceding tone and no voice reception from the calling party.
 - The telephone's speaker is muted
- Page Mode
 - The telephone rings (using its default ring tone) before automatically starting a receive-only voice call
 - The telephone's microphone is muted and the speaker volume is set to maximum
 - The number of rings is set by the parameter `phone_autoanswer_ring_count`.
 - If the ring tone is continuous (ie has no OFF duration), the tone will play for a fixed period of time equal to `phone_autoanswer_ring_count` x 10ms.
- Off
 - The telephone will not autoanswer incoming calls

3.2 Dictionary of terms

Busy tone

A tone played to the user to indicate that a call has failed because the called party is engaged

Call progress tone

One of a number of different tones played to the user to indicate the status of a call. Dial tone, busy tone and NU tone are all examples of call progress tones.

Confidence tones

Tones played to the user to indicate that dialling is in progress, by imitating DTMF tones used by analog telephones.

Dial tone

A tone played to the user to indicate that the telephone is ready to dial – ie it is off hook and waiting for a button to be pressed to initiate a call.

Dialling

Used to describe the process of initiating a call, usually by pressing a memory button or a series of digit buttons.

DTMF

Standing for "dual tone multi-frequency", the dialling digit tones produced by a touch-tone phone. Commonly used for signalling in analogue systems.

GAI-TRONICS

Handset phone

Used to denote a telephone from the GAI-Tronics Titan or Commander product ranges, with a separate handset attached to the main telephone body by a heavy duty flexible cord. No separate loudspeaker is fitted to these models.

Hands-Free phone

Used to denote a telephone from the GAI-Tronics Help Point or Vandal Resistant product ranges, with a microphone and speaker integrated into a flat panel. No corded handset is fitted to these models.

LNR

Standing for "last number redial", this is a button provided on some models of GAI-Tronics phone to redial the last manually dialed number.

Memory dial number

On an analogue or cellular phone, memory numbers are pre-stored digit sequences used to start calls. With VoIP these can also be URI's rather than numbers, but are still referred to in the same way.

Mute

A function to temporarily mute the microphone so that the remote party cannot hear. On GAI-Tronics telephones this function is provided by the "S" button.

NU tone

Number unobtainable tone – used to indicate that a call cannot connect due to the end point not being recognised.

Off hook

Used to denote the state of a telephone during an active call, or when a call has been initiated. For a handset phone, off hook usually means that the handset is lifted.

On hook

Used to denote a telephone in the idle state – no call started or answered. A telephone is still on hook when it is ringing on an incoming call. For a handset phone, on hook usually means the handset is not lifted. If a call is terminated whilst the handset is still lifted (for example by the CALL LIMIT timer), the telephone is placed into the on hook state. For a hands-free phone, on hook means that no ON or WAKE & DIAL button has been pressed following a terminated call or reset.

Register Fail tone

A tone played to the user initiating a call to indicate that the telephone is not currently registered with a registrar, meaning that a call cannot be made.

Ring tone

A tone played to the user initiating a call to indicate that the call has been placed but not yet answered. This usually signifies that the remote end is ringing.

Ringling

A loud alert tone made by the telephone indicating that an incoming call is ready to be answered.

Secrecy (mute)

A function to temporarily mute the microphone so that the remote party cannot hear. On GAI-Tronics telephones this function is provided by the "S" button.

Sidetone

On handset phones, part of the microphone signal is fed to the earpiece so that the user can hear his or her own voice during the call. This makes it a more natural experience, and has been a feature of analogue telephones since their invention. Not used on hands-free phones.

4. Setting up and Configuring the Telephones.

Each telephone must be configured for use on the intended network. Most models have memory-dial locations, which will need to be set up. The telephone also has a range of customisable features. All of these can be set up using one of 3 different methods:

- Web pages (the simplest and quickest method for configuring an individual phone)
- SNMP
- Downloading configuration files (the most efficient method for multiple updates)

Note:

All of the above access methods require you to know the unit's username and password.

Please ensure these details are recorded securely once set or changed.

4.1 Web Page Structure

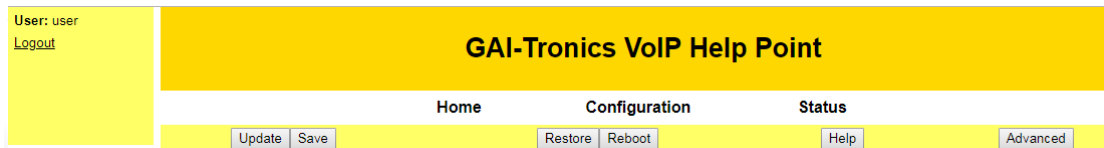

All the web pages in the telephone have a common header section showing the name of the device, the current user name, links to the 3 main sections (Home, Configuration & Status), and controls for the configuration process (Update, Save, Restore, Reboot etc).

The **Home** Page shows information about the 4 VoIP Accounts (SIP servers) that it can register with:

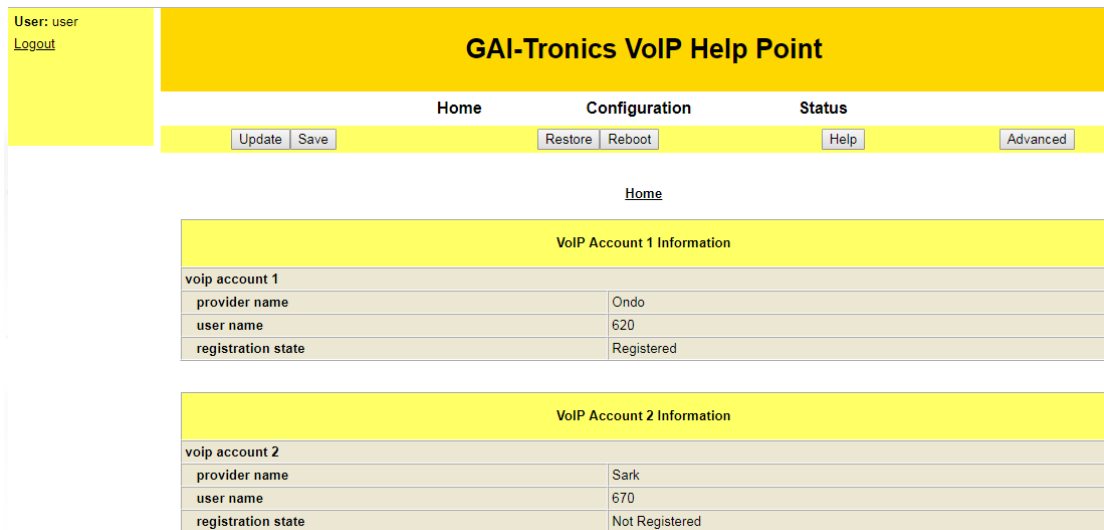

As well as local network information about the telephone:

Local Network Configuration	
net current ip address	10.113.130.171
net current netmask	255.255.255.0
net current host name	
net current gateway address	10.113.130.1
net dns primary address	10.37.71.1
net dns secondary address	0.0.0.0
sip local port (1024-65535)	5060

Selecting **Configuration** allows access to the configuration main pages (shown in a black bar across the top) and the various sub-pages (shown down the left-hand side of each page, eg:

GAI-TRONICS

The screenshot displays the GAI-Tronics VoIP Commander web interface. At the top left, a user is logged in as 'user' with a 'Logout' link. The main header is yellow and contains the title 'GAI-Tronics VoIP Commander'. Below the header is a navigation bar with 'Home', 'Configuration', and 'Status' tabs. A secondary bar contains buttons for 'Update', 'Save', 'Restore', 'Reboot', 'Help', and 'Advanced'. The main content area has a dark grey navigation bar with 'System', 'VoIP Accounts', 'User Configuration', and 'Phone Configuration' tabs. A breadcrumb trail shows 'Home >> Configuration >> System >> Accounts'. The left sidebar lists sub-pages: 'System' (selected), 'Accounts', 'Date/Time', 'Network Configuration', 'DNS Configuration', 'Remote Configuration Access', 'Update Parameters', 'Phone Maintenance', 'System Identification', 'Fault Log Configuration', 'Input/Output Configuration', and 'Audio Path Test'. The main content area shows the 'Accounts' sub-page with two input fields: 'phone user name' (containing 'user') and 'phone user password (min 6)'. A 'Sub pages' callout points to the sidebar, and a 'Position in tree structure' callout points to the breadcrumb trail.

The list of sub-pages down the left-hand side changes according to the main page selected from the main page bar. The example above shows the Accounts sub-page within the System main page. The current position in the web page structure is shown below the main page bar.

The “Advanced” button toggles the lists of main and sub-pages between a basic set (sufficient for most configuration tasks) and an advanced set containing more detail. Note that some parameters on individual sub-pages may also be hidden in basic mode.

The web page structure within the configuration section is shown below. Pages shown in grey are visible only in advanced mode.

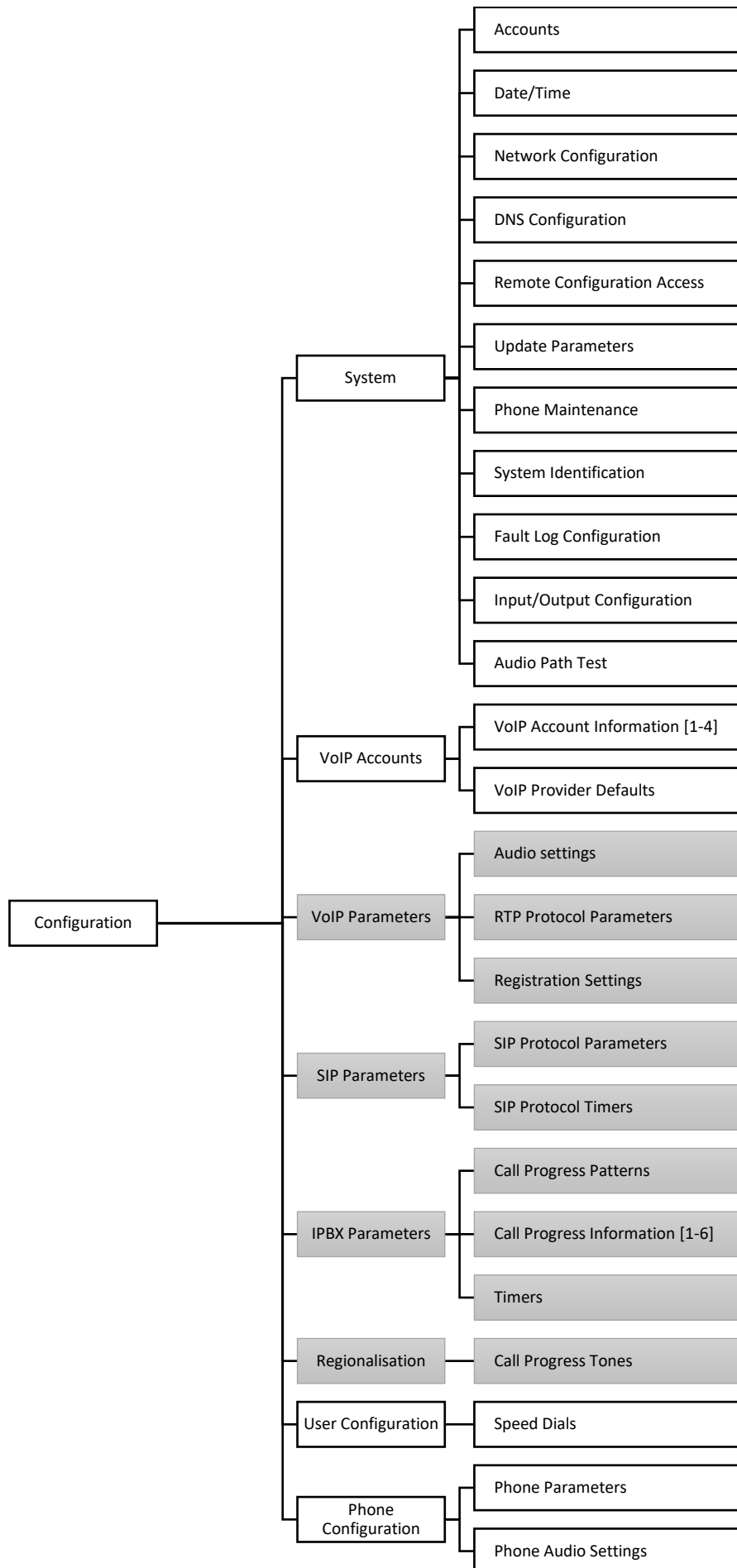

4.2 Quick Start

The factory defaults will generally be sufficient in most cases, but the following steps must be taken as a minimum:

- Provide an Ethernet connection and power (either 24-48Vdc or PoE)
- Ensure that a DHCP server is available on the network, and that the IP address allocated to the telephone can be discovered (DHCP is the normal factory default provisioning method). If DHCP fails (or there is no DHCP server) the telephone will revert to a default IP address of **192.168.1.2** after a few minutes
- Using a web browser, browse to the IP address.
- When prompted, enter the user name and password (Defaults: **user & password**)
- From the Home Page, select the Configuration section, and from that the VoIP Accounts main page
- On the VoIP Account 1 Information sub-page, enter:
 - The user name (its extension number on the SIP server)
 - Domain name, Proxy domain name and Register domain name – set all of these to the IP address of the SIP server
 - Auth user password – set to the authentication password for the extension on the SIP server.
 - Ensure Provider enable and Register enable are both set to enabled.
 - Check that the registration state changes to “registered”
- Program any speed dial memories using the User Configuration main page

4.3 Web Page Controls

The following controls appear on every web page:

- Update – commits any change to any parameters on the current page. Navigating to a different page without clicking update will lose any changes made. Update will usually change the parameter immediately, but it will not be permanently saved (ie changes will be lost if the phone is rebooted or power-cycled. To make changes permanent, use Save.
- Save – saves the current configuration to flash memory
- Restore – restores the telephone to its last saved configuration
- Reboot – performs a soft reboot of the telephone.

Note - if any server address or domain name is changed via a web page, the telephone must be rebooted (or power cycled) for the change to take effect.

4.4 Configuration Parameter Descriptions

All the available parameters are listed below, in the order in which they appear within the web page structure, working through each main page and all its sub-pages in turn.

The information for each parameter is set out in a standard layout, identifying the main web page and sub page where it is located.

System Main Page
 Accounts Sub Page
 phone user name Parameter

Description:
 User configuration access name

Basic or advanced: Basic
 Range check: 1 to 15 chars
 Default value: user
 Config file parameter name: phone_user_name

Update Save	
System	VoIP Accounts
System	
Accounts	
Date/Time	phone user name
	phone user password (min 6)
Network Configuration	
DNS Configuration	
Remote Configuration Access	
Update Parameters	
Phone Maintenance	
System Identification	
Fault Log Configuration	
Input/Output Configuration	
Audio Path Test	

Note that the default values listed here relate to the Titan 18 button product. Parameters may vary by product model - refer to referenced sections for details.

GAI-TRONICS

System

Accounts

phone user name

Description:

User configuration access name

Basic or advanced: Basic

Range check: 1 to 15 chars

Default value: user

Default value differs with model variant? : N

Config file parameter name: phone_user_name

System

Accounts

phone user password

Description:

User password

Basic or advanced: Basic

Range check: 6 to 23 chars

Default value: password

Default value differs with model variant? : N

Config file parameter name: phone_user_password

System

Date/Time

phone date

Description:

Current date

Basic or advanced: Basic

Range check:

Default value:

Default value differs with model variant? : N

Config file parameter name: phone_date

System

Date/Time

phone time

Description:

Current time

Basic or advanced: Basic

Range check:

Default value:

Default value differs with model variant? : N

Config file parameter name: phone_time

System

Date/Time

GAI-TRONICS

phone time zone

Description:

Local time zone difference from GMT (in hours)

Basic or advanced: Basic

Range check: -12 to 13

Default value: 0

Default value differs with model variant? : N

Config file parameter name: phone_time_zone

System

Date/Time

phone time zone minutes

Description:

Sets the current time zone minutes (used in conjunction with phone time zone hours).

Basic or advanced: Basic

Range check: -59 to 59

Default value: 0

Default value differs with model variant? : N

Config file parameter name: phone_time_zone_minutes

System

Date/Time

phone daylight savings enable

Description:

Enable local application of daylight savings time

Basic or advanced: Basic

Range check: enabled / disabled

Default value: disabled

Default value differs with model variant? : N

Config file parameter name: phone_daylight_savings_enable

System

Date/Time

phone timeserver enable

Description:

Enable use of network timeserver

Basic or advanced: Basic

Range check: enabled / disabled

Default value: disabled

Default value differs with model variant? : N

Config file parameter name: phone_timeserver_enable

System

Date/Time

phone timeserver domain name

Description:

GAI-TRONICS

Fully qualified domain name (including an optional port number) for the NTP/SNTP timeserver server. Reboot required after update.

Basic or advanced: Basic

Range check:

Default value:

Default value differs with model variant? : N

Config file parameter name: phone_timeserver_domain_name

System

Network Configuration

net static ip address

Description:

Manually configured IP address (or address automatically assigned and saved)

Basic or advanced: Basic

Range check:

Default value: 192.168.1.2

Default value differs with model variant? : N

Config file parameter name: net_static_ip_address

System

Network Configuration

net static netmask

Description:

Static net mask. Note the mask cannot be wider than the default mask for the address class. Eg, for 192.168.x.x (a class C address), any setting wider than 255.255.255.0 will be ignored.

Basic or advanced: Basic

Range check:

Default value: 255.255.255.0

Default value differs with model variant? : N

Config file parameter name: net_static_netmask

System

Network Configuration

net static gateway address

Description:

Manually configured gateway IP address (or address automatically assigned and saved)

Basic or advanced: Basic

Range check:

Default value: 0.0.0.0

Default value differs with model variant? : N

Config file parameter name: net_static_gateway_address

System

Network Configuration

net isp dhcp enable

Description:

GAI-TRONICS

Enable use of DHCP for automatic local IP address configuration

Basic or advanced: Basic

Range check: enabled / disabled

Default value: enabled

Default value differs with model variant? : Y

Config file parameter name: net_isp_dhcp_enable

System

Network Configuration

net isp dhcp discover duration (s)

Description:

The period of time for which the telephone will continue to try to request an IP address via DHCP. If this period expires with no DHCP success, it will use the static address and netmask values. A value of 0 will cause it to try indefinitely.

Basic or advanced: Basic

Range check:

Default value: 60

Default value differs with model variant? : N

Config file parameter name: net_isp_dhcp_discover_duration

System

Network Configuration

net host name

Description:

Unique device ID used during DHCP. If blank, the phone will use the factory set parameter "net unique device id" from the System Identification page.

Basic or advanced: Advanced

Range check: max 48 chars

Default value:

Default value differs with model variant? : N

Config file parameter name: net_host_name

System

DNS Configuration

net dns primary address

Description:

Manually configured IP address of primary domain name server (DNS). Reboot required after update.

Basic or advanced: Basic

Range check:

Default value: 0.0.0.0

Default value differs with model variant? : N

Config file parameter name: net_dns_primary_address

System

DNS Configuration

net dns secondary address

Description:

GAI-TRONICS

Manually configured IP address of backup domain name server (DNS). Reboot required after update.

Basic or advanced: Basic

Range check:

Default value: 0.0.0.0

Default value differs with model variant? : N

Config file parameter name: net_dns_secondary_address

System

Remote Configuration Access

phone web external server enable

Description:

Enable access to configuration procedures from external IP addresses

Basic or advanced: Basic

Range check: enabled / disabled

Default value: enabled

Default value differs with model variant? : N

Config file parameter name: phone_web_external_server_enable

System

Remote Configuration Access

phone web server port

Description:

Port number for configuration web server

Basic or advanced: Basic

Range check:

Default value: 80

Default value differs with model variant? : N

Config file parameter name: phone_web_server_port

System

Remote Configuration Access

phone telnet server enable

Description:

Enable telnet (required for GAI-Tronics TMA monitoring software, see section 11.)

Basic or advanced: Basic

Range check: enabled / disabled

Default value: disabled

Default value differs with model variant? : N

Config file parameter name: phone_telnet_server_enable

System

Update Parameters

phone update domain name

Description:

Address or FQDN of the TFTP server to be used for configuration file and firmware updates. Reboot required after update.

GAI-TRONICS

Basic or advanced: Basic
Range check:
Default value:
Default value differs with model variant? : N
Config file parameter name: phone_update_domain_name

System

Update Parameters

phone update control file

Description:
Name of the update control file used for TFTP download. See section 8

Basic or advanced: Basic
Range check:
Default value:
Default value differs with model variant? : N
Config file parameter name: phone_update_control_file

System

Update Parameters

phone configuration update now

Description:
Perform a manual configuration update via TFTP. Setting this to "enable", then clicking "update" will cause the phone to initiate an update immediately. The option button will then revert to being "disabled".

Basic or advanced: Basic
Range check: enabled / disabled
Default value: disabled
Default value differs with model variant? : N
Config file parameter name: phone_configuration_update_now

System

Update Parameters

phone configuration update enable

Description:
Control to enable automatic, periodic updating of configuration via TFTP

Basic or advanced: Basic
Range check: enabled / disabled
Default value: enabled
Default value differs with model variant? : N
Config file parameter name: phone_configuration_update_enable

System

Update Parameters

phone configuration update on reset

Description:
Control to enable automatic update of configuration on reset (via TFTP)

Basic or advanced: Basic

GAI-TRONICS

Range check: enabled / disabled
Default value: enabled
Default value differs with model variant? : N
Config file parameter name: phone_configuration_update_on_reset

System

Update Parameters

phone configuration update periodic delay

Description:
Periodic delay in seconds between configuration update checks

Basic or advanced: Basic
Range check:
Default value: 3600
Default value differs with model variant? : N
Config file parameter name: phone_configuration_update_periodic_delay

System

Update Parameters

phone configuration update random delay

Description:
Uniform random delay in seconds applied when contact with the update server fails

Basic or advanced: Basic
Range check:
Default value: 240
Default value differs with model variant? : N
Config file parameter name: phone_configuration_update_random_delay

System

Update Parameters

phone firmware update now

Description:
Perform a manual firmware update via TFTP. Setting this to "enable", then clicking "update" will cause the phone to initiate an update immediately. The option button will then revert to being "disabled".

Basic or advanced: Basic
Range check: enabled / disabled
Default value: disabled
Default value differs with model variant? : N
Config file parameter name: phone_firmware_update_now

System

Update Parameters

phone firmware update enable

Description:
Control to enable automatic, periodic updating of firmware via TFTP

Basic or advanced: Basic
Range check: enabled / disabled

GAI-TRONICS

Default value: enabled
Default value differs with model variant? : N
Config file parameter name: phone_firmware_update_enable

System

Update Parameters

phone firmware update on reset

Description:
Control to enable automatic update of firmware on reset (via TFTP)

Basic or advanced: Basic
Range check: enabled / disabled
Default value: enabled
Default value differs with model variant? : N
Config file parameter name: phone_firmware_update_on_reset

System

Update Parameters

phone firmware update periodic delay

Description:
Periodic delay in seconds between firmware update checks

Basic or advanced: Basic
Range check:
Default value: 86400
Default value differs with model variant? : N
Config file parameter name: phone_firmware_update_periodic_delay

System

Update Parameters

phone firmware update random delay

Description:
Uniform random delay in seconds applied when contact with the update server fails

Basic or advanced: Basic
Range check:
Default value: 240
Default value differs with model variant? : N
Config file parameter name: phone_firmware_update_random_delay

System

Phone Maintenance

phone help url

Description:
Link to tech documentation for the product

Basic or advanced: Basic
Range check: max 128 chars
Default value: <https://www.hubbell.com/gai-tronics/en/voip-support>
Default value differs with model variant? : N
Config file parameter name: phone_help_url

GAI-TRONICS

System

Phone Maintenance

net syslog enable

Description:

Control to enable transmission of SYSLOG messages. Used by GAI-Tronics TMA monitoring software, see section 11.

Basic or advanced: Basic

Range check: enabled / disabled

Default value: disabled

Default value differs with model variant? : N

Config file parameter name: net_syslog_enable

System

Phone Maintenance

net syslog server

Description:

Fully qualified domain name for the SYSLOG server. Reboot required after update. Used by GAI-Tronics TMA monitoring software, see section 11.

Basic or advanced: Basic

Range check: max 64 chars

Default value:

Default value differs with model variant? : N

Config file parameter name: net_syslog_server

System

Phone Maintenance

net syslog server port

Description:

Syslog server port

Basic or advanced: Basic

Range check: max 11 chars

Default value: 514

Default value differs with model variant? : N

Config file parameter name: net_syslog_server_port

System

Phone Maintenance

net syslog facility

Description:

Sets the SYSLOG message facility level, as per RFC3164. Used by GAI-Tronics TMA monitoring software, see section 11.

Basic or advanced: Basic

Range check: max 11 chars

Default value: 14

Default value differs with model variant? : N

Config file parameter name: net_syslog_facility

GAI-TRONICS

System

Phone Maintenance

net syslog severity

Description:

Sets the SYSLOG message severity level, as per RFC3164. Used by GAI-Tronics TMA monitoring software, see section 11.

Basic or advanced: Basic

Range check: max 11 chars

Default value: 5

Default value differs with model variant? : N

Config file parameter name: net_syslog_severity

System

Phone Maintenance

snmp server enable

Description:

Enable an external SNMP application to access this telephone, see section 9

Basic or advanced: Basic

Range check: enabled / disabled

Default value: disabled

Default value differs with model variant? : N

Config file parameter name: snmp_server_enable

System

Phone Maintenance

snmp community 1

Description:

SNMP community string 1, see section 9

Basic or advanced: Basic

Range check: max 64 chars

Default value: public

Default value differs with model variant? : N

Config file parameter name: snmp_community_1

System

Phone Maintenance

snmp community 1 access

Description:

Access level for SNMP community 1, see section 9

Basic or advanced: Basic

Range check: 0 to 3

Default value: 2

Default value differs with model variant? : N

Config file parameter name: snmp_community_1_access

System

Phone Maintenance

snmp community 2

Description:
SNMP community string 2, see section 9

Basic or advanced: Basic
Range check: max 64 chars
Default value: private
Default value differs with model variant? : N
Config file parameter name: snmp_community_2

System

Phone Maintenance

snmp community 2 access

Description:
Access level for SNMP community 2, see section 9

Basic or advanced: Basic
Range check: 0 to 3
Default value: 3
Default value differs with model variant? : N
Config file parameter name: snmp_community_2_access

System

Phone Maintenance

snmp trap enable

Description:
Enable or disable the sending of SNMP traps, see section 9

Basic or advanced: Basic
Range check: enabled / disabled
Default value: disabled
Default value differs with model variant? : N
Config file parameter name: snmp_trap_enable

System

Phone Maintenance

snmp trap server

Description:
IP address or FQDN of SNMP server receiving traps, see section 9.

Basic or advanced: Basic
Range check: max 64 chars
Default value:
Default value differs with model variant? : N
Config file parameter name: snmp_trap_server

System

Phone Maintenance

snmp trap community

Description:

GAI-TRONICS

Community string for SNMP traps, see section 9.

Basic or advanced: Basic
Range check: max 63 chars
Default value: public
Default value differs with model variant? : N
Config file parameter name: snmp_trap_community

System

System Identification

phone copyright notice

Description:
Software copyright notice, Including current firmware version

Basic or advanced: Basic
Range check: view only
Default value:
Default value differs with model variant? : N
Config file parameter name: phone_copyright_notice

System

System Identification

phone unit type

Description:
Model or part number of the product. Factory assigned.

Basic or advanced: Basic
Range check: view only
Default value:
Default value differs with model variant? : N
Config file parameter name: phone_unit_type

System

System Identification

phone unit serial number

Description:
Product serial number.. Factory assigned.

Basic or advanced: Basic
Range check: view only
Default value:
Default value differs with model variant? : N
Config file parameter name: phone_unit_serial_number

System

System Identification

phone board type

Description:
Model or part number of the main PCB. Factory assigned.

Basic or advanced: Basic
Range check: view only

GAI-TRONICS

Default value:
Default value differs with model variant? : N
Config file parameter name: phone_board_type

System

System Identification

phone board serial number

Description:
Main PCB serial number. Factory assigned.

Basic or advanced: Basic
Range check: view only
Default value:
Default value differs with model variant? : N
Config file parameter name: phone_board_serial_number

System

System Identification

phone daughter type

Description:
Model or part number of the keypad or carrier PCB. Factory assigned.

Basic or advanced: Basic
Range check: view only
Default value:
Default value differs with model variant? : N
Config file parameter name: phone_daughter_type

System

System Identification

phone daughter serial number

Description:
Serial number of the keypad or carrier PCB. Factory assigned.

Basic or advanced: Basic
Range check: view only
Default value:
Default value differs with model variant? : N
Config file parameter name: phone_daughter_serial_number

System

System Identification

phone boot rom revision

Description:
Read from the last loaded update control file. Used by the phone to control whether a bootfile update is needed. See section 8.1.1

Basic or advanced: Basic
Range check: view only
Default value:
Default value differs with model variant? : N
Config file parameter name: phone_boot_rom_revision

System

System Identification

phone firmware revision

Description:

Read from the last loaded update control file. Used by the phone to control whether a firmware update is needed. See section 8.1.1. Note this may not be the actual firmware version, which is displayed in the copyright notice above.

Basic or advanced: Basic

Range check: view only

Default value:

Default value differs with model variant? : N

Config file parameter name: phone_firmware_revision

System

System Identification

phone configuration revision

Description:

Read from the last loaded update control file. Used by the phone to control whether a configuration file update is needed. See section 8.1.1

Basic or advanced: Basic

Range check: max 15 chars

Default value: Specific to model of telephone.

Default value differs with model variant? : Y

Config file parameter name: phone_configuration_revision

System

System Identification

phone keypad revision

Description:

Factory assigned parameter

Basic or advanced: Basic

Range check: view only

Default value:

Default value differs with model variant? : N

Config file parameter name: phone_processor_chip_id

System

System Identification

net hardware mac address

Description:

Ethernet MAC address assigned during manufacture

Basic or advanced: Basic

Range check: view only

Default value:

Default value differs with model variant? : N

Config file parameter name: net_hardware_mac_address

GAI-TRONICS

System

System Identification

net unique device id

Description:

Unique device ID including Ethernet MAC used for DHCP and update operations. Factory set, not editable.

Basic or advanced: Basic

Range check: view only

Default value:

Default value differs with model variant? : N

Config file parameter name: net_unique_device_id

System

System Identification

snmp system description

Description:

snmp system description, see section 9

Basic or advanced: Advanced

Range check:

Default value:

Default value differs with model variant? : N

Config file parameter name: snmp_system_description

System

System Identification

snmp system name

Description:

snmp system name, see section 9

Basic or advanced: Advanced

Range check:

Default value:

Default value differs with model variant? : N

Config file parameter name: snmp_system_name

System

System Identification

snmp system contact

Description:

snmp system contact, see section 9

Basic or advanced: Advanced

Range check:

Default value:

Default value differs with model variant? : N

Config file parameter name: snmp_system_contact

System

System Identification

snmp system location

Description:
snmp system location, see section 9

Basic or advanced: Advanced
Range check:
Default value:
Default value differs with model variant? : N
Config file parameter name: snmp_system_location

System

Fault Log Configuration

fault status mask

Description:
Coded representation of diagnostic faults. See section 10 for code explanation.

Basic or advanced: Basic
Range check: view only
Default value: 00000000
Default value differs with model variant? : N
Config file parameter name: fault_status_mask

System

Fault Log Configuration

fault clear mask

Description:
Code to clear diagnostic faults. See section 10 for code explanation.

Basic or advanced: Basic
Range check: 00000000 to ffffffff
Default value: 00000000
Default value differs with model variant? : N
Config file parameter name: fault_clear_mask

System

Fault Log Configuration

send fault log now

Description:
Select enabled, then Update to send fault log immediately

Basic or advanced: Basic
Range check: enabled / disabled
Default value: disabled
Default value differs with model variant? : N
Config file parameter name: send_fault_log_now

System

Fault Log Configuration

fault log prefix

Description:

GAI-TRONICS

Prefix to fault log file name. filenames are in the format: prefix + yymmddhhmmss.log. See section 10

Basic or advanced: Basic
Range check: max 63 chars
Default value:
Default value differs with model variant? : N
Config file parameter name: fault_log_prefix

System

Fault Log Configuration

fault log ftp server domain

Description:
IP address or FQDN of FTP server used for fault logs. Reboot required after update. See section 10

Basic or advanced: Basic
Range check:
Default value:
Default value differs with model variant? : N
Config file parameter name: fault_log_ftp_server_domain

System

Fault Log Configuration

fault log ftp server port

Description:
FTP server port for fault logs. See section 10

Basic or advanced: Basic
Range check: 0 to 65535
Default value: 21
Default value differs with model variant? : N
Config file parameter name: fault_log_ftp_server_port

System

Fault Log Configuration

fault log ftp server username

Description:
FTP login name for fault logs. See section 10

Basic or advanced: Basic
Range check:
Default value:
Default value differs with model variant? : N
Config file parameter name: fault_log_ftp_server_username

System

Fault Log Configuration

fault log ftp server password

Description:
FTP password for fault logs. See section 10

GAI-TRONICS

Basic or advanced: Basic
Range check: max 63 chars
Default value:
Default value differs with model variant? : N
Config file parameter name: fault_log_ftp_server_password

System

Fault Log Configuration

fault log ftp server folder

Description:
Folder path on FTP server for fault logs. See section 10

Basic or advanced: Basic
Range check: max 127 chars
Default value:
Default value differs with model variant? : N
Config file parameter name: fault_log_ftp_server_folder

System

Input/Output Configuration

ptt mode enabled

Description:
Set the function of a PTT / mute button. Enable to act as push-to-talk, disable to act as push-to-mute. Refer to section 4.5.2. Do not enable unless a PTT / Mute button (function code 3) is defined.

Basic or advanced: Basic
Range check: enabled / disabled
Default value: disabled
Default value differs with model variant? : N
Config file parameter name: ptt_mode_enabled

System

Input/Output Configuration

keyboard stuck key timeout

Description:
Period in seconds that a key must be continuously pressed to flag a "Keyboard Error" fault event. 0 disables

Basic or advanced: Basic
Range check: 0 to 127
Default value: 0
Default value differs with model variant? : N
Config file parameter name: keyboard_stuck_key_timeout

System

Input/Output Configuration

led relay map string

Description:
Defines LED, relay and output functions. See code explanations, section 4.5.4

Basic or advanced: Basic

GAI-TRONICS

Range check: max 127 chars
Default value: 0 0 0 0 0 0 0
Default value differs with model variant? : Y
Config file parameter name: led_relay_map_string

System

Input/Output Configuration

button map string

Description:

Defines button and input functions. See code explanations, section 4.5.2

Basic or advanced: Basic
Range check: max 127 chars
Default value: 2m1 2m2 2m3 1c1 1c2 1c3 1c4 1c5 1c6 1c7 1c8 1c9 1c* 1c0 1c#
5 0 4 0 0 0 0 6
Default value differs with model variant? : Y
Config file parameter name: button_map_string

System

Input/Output Configuration

ipbx input pattern voip

Description:

Allows rules to be set up governing which numbers and sequences can be used when using a numeric keypad. See code explanations, section 4.5.6.

Basic or advanced: Advanced
Range check:
Default value: e*e#~+
Default value differs with model variant? : N
Config file parameter name: ipbx_input_pattern_voip

System

Audio Path Test

apt enabled

Description:

Control to enable automatic, periodic audio path test. See section 6.

Basic or advanced: Basic
Range check: enabled / disabled
Default value: disabled
Default value differs with model variant? : N
Config file parameter name: apt_enabled

System

Audio Path Test

apt now

Description:

Perform a manual audio path test. Setting this to "enable", then clicking "update" will cause the phone to initiate test immediately. The option button will then revert to being "disabled". See section 6.

Basic or advanced: Basic

GAI-TRONICS

Range check: enabled / disabled
Default value: disabled
Default value differs with model variant? : N
Config file parameter name: apt_now

System

Audio Path Test

apt time

Description:

Time of day (24h format hh:mm:ss) to perform an automatic audio path test. See section 6.

Basic or advanced: Basic
Range check: 00:00:00 to 23:59:59
Default value: 12:00:00
Default value differs with model variant? : N
Config file parameter name: apt_time

System

Audio Path Test

apt interval

Description:

Interval in hours between automatic audio path tests. See section 6.

Basic or advanced: Basic
Range check: 1 to 24
Default value: 24
Default value differs with model variant? : N
Config file parameter name: apt_interval

System

Audio Path Test

apt count

Description:

No of measurements to take during an audio path test. See section 6.

Basic or advanced: Basic
Range check: 1 to 10
Default value: 1
Default value differs with model variant? : N
Config file parameter name: apt_count

System

Audio Path Test

apt ok count

Description:

No of measurements which must pass in order to consider the test to have passed. See section 6.

Basic or advanced: Basic
Range check: 1 to apt count
Default value: 1

GAI-TRONICS

Default value differs with model variant? : N
Config file parameter name: apt_ok_count

System

Audio Path Test

apt low threshold

Description:
Minimum difference between silence and tone levels to be considered a pass.
See section 6.

Basic or advanced: Advanced
Range check: 1000 to 10000
Default value: 3000
Default value differs with model variant? : N
Config file parameter name: apt_low_threshold

System

Audio Path Test

apt high threshold

Description:
Maximum difference between silence and tone levels to be considered a pass.
See section 6.

Basic or advanced: Advanced
Range check: 1000 to 10000
Default value: 5000
Default value differs with model variant? : N
Config file parameter name: apt_high_threshold

System

Audio Path Test

apt frequency

Description:
Main test tone frequency. See section 6.

Basic or advanced: Advanced
Range check: 1000 to 20000
Default value: 12000
Default value differs with model variant? : N
Config file parameter name: apt_frequency

System

Audio Path Test

apt frequency band

Description:
Variation in test tone frequency. See section 6.

Basic or advanced: Advanced
Range check: 100 to 5000
Default value: 400
Default value differs with model variant? : N
Config file parameter name: apt_frequency_band

System

Audio Path Test

apt output level

Description:

Test tone level. See section 6.

Basic or advanced: Advanced

Range check: 1 to 30000

Default value: 11000

Default value differs with model variant? : N

Config file parameter name: apt_output_level

System

Audio Path Test

apt status

Description:

APT test status. See section 6.

Basic or advanced: Basic

Range check: view only

Default value:

Default value differs with model variant? : N

Config file parameter name: apt_status

System

Audio Path Test

apt last test date

Description:

Details of last audio path test. See section 6.

Basic or advanced: Basic

Range check: view only

Default value:

Default value differs with model variant? : N

Config file parameter name: apt_last_test_date

System

Audio Path Test

apt last test count

Description:

Details of last audio path test. See section 6.

Basic or advanced: Basic

Range check: view only

Default value:

Default value differs with model variant? : N

Config file parameter name: apt_last_test_count

System

Audio Path Test

apt last test ok count

Description:

Details of last audio path test. See section 6.

Basic or advanced: Basic

Range check: view only

Default value:

Default value differs with model variant? : N

Config file parameter name: apt_last_test_ok_count

System

Audio Path Test

apt last test passed count

Description:

Details of last audio path test. See section 6.

Basic or advanced: Basic

Range check: view only

Default value:

Default value differs with model variant? : N

Config file parameter name: apt_last_test_passed_count

System

Audio Path Test

apt last test failed count

Description:

Details of last audio path test. See section 6.

Basic or advanced: Basic

Range check: view only

Default value:

Default value differs with model variant? : N

Config file parameter name: apt_last_test_failed_count

System

Audio Path Test

apt last test result

Description:

Details of last audio path test. See section 6.

Basic or advanced: Basic

Range check: view only

Default value:

Default value differs with model variant? : N

Config file parameter name: apt_last_test_result

System

Audio Path Test

apt last test silence

Description:

GAI-TRONICS

Details of last audio path test. See section 6.

Basic or advanced: Advanced

Range check: view only

Default value:

Default value differs with model variant? : N

Config file parameter name: apt_last_test_silence

System

Audio Path Test

apt last test tone

Description:

Details of last audio path test. See section 6.

Basic or advanced: Advanced

Range check: view only

Default value:

Default value differs with model variant? : N

Config file parameter name: apt_last_test_tone

System

Audio Path Test

apt last test difference

Description:

Details of last audio path test. See section 6.

Basic or advanced: Advanced

Range check: view only

Default value:

Default value differs with model variant? : N

Config file parameter name: apt_last_test_difference

System

Audio Path Test

apt last test low threshold

Description:

Details of last audio path test. See section 6.

Basic or advanced: Advanced

Range check: view only

Default value:

Default value differs with model variant? : N

Config file parameter name: apt_last_test_low_threshold

System

Audio Path Test

apt last test high threshold

Description:

Details of last audio path test. See section 6.

Basic or advanced: Advanced

Range check: view only

GAI-TRONICS

Default value:
Default value differs with model variant? : N
Config file parameter name: apt_last_test_high_threshold

VoIP Accounts

VoIP Account Information 1

provider name

Description:
Provider or server name for identification purposes. Not used by SIP.
Parameters for VoIP Account 1 are repeated for providers 2, 3 and 4

Basic or advanced: Basic
Range check:
Default value:
Default value differs with model variant? : N
Config file parameter name: _voip_provider_1.provider_name

VoIP Accounts

VoIP Account Information 1

provider changed

Description:
Setting this to "enabled" and then clicking "update" will force the provider credentials to be sent to the server, including forcing registration or deregistration. It is recommended to set this to "enabled" whenever any detail on this page is updated.

Basic or advanced: Basic
Range check: enabled / disabled
Default value: disabled
Default value differs with model variant? : N
Config file parameter name: _voip_provider_1.provider_changed

VoIP Accounts

VoIP Account Information 1

provider enable

Description:
Enable this VoIP provider account.

Basic or advanced: Basic
Range check: enabled / disabled
Default value: enabled
Default value differs with model variant? : N
Config file parameter name: _voip_provider_1.provider_enable

VoIP Accounts

VoIP Account Information 1

registration state

Description:
Read only field showing registration status for this provider

Basic or advanced: Basic
Range check: view only

GAI-TRONICS

Default value:
Default value differs with model variant? : N
Config file parameter name: _voip_provider_1.registration_state

VoIP Accounts

VoIP Account Information 1

display name

Description:
Holds the display name that will be displayed to other SIP clients if making an IP call

Basic or advanced: Advanced
Range check:
Default value:
Default value differs with model variant? : N
Config file parameter name: _voip_provider_1.display_name

VoIP Accounts

VoIP Account Information 1

user name

Description:
Identifies the user name to use when logging into the service provider's server. Commonly in the form of an E.164 number. This is used by SIP

Basic or advanced: Basic
Range check:
Default value:
Default value differs with model variant? : N
Config file parameter name: _voip_provider_1.user_name

VoIP Accounts

VoIP Account Information 1

domain name

Description:
Specifies the domain name assigned to the user name. This is used by SIP

Basic or advanced: Basic
Range check:
Default value:
Default value differs with model variant? : N
Config file parameter name: _voip_provider_1.domain_name

VoIP Accounts

VoIP Account Information 1

auth user name

Description:
Specifies the user name used for authentication purposes. Can be left blank, in which case authentication will use _voip_provider_n.user_name.

Basic or advanced: Advanced
Range check:
Default value:

GAI-TRONICS

Default value differs with model variant? : N
Config file parameter name: _voip_provider_1.auth_user_name

VoIP Accounts

VoIP Account Information 1

auth user password

Description:
Specifies the password to use for authentication purposes

Basic or advanced: Basic
Range check:
Default value:
Default value differs with model variant? : N
Config file parameter name: _voip_provider_1.auth_user_password

VoIP Accounts

VoIP Account Information 1

proxy domain name

Description:
SIP server, with optional port (eg 192.168.1.100:5060). If the port is omitted, the port value from SIP protocol parameters / sip remote port is used. Reboot required after update.

Basic or advanced: Basic
Range check:
Default value:
Default value differs with model variant? : N
Config file parameter name: _voip_provider_1.proxy_domain_name

VoIP Accounts

VoIP Account Information 1

register enable

Description:
Enable registration on this VoIP provider account. Note that the provider account must be enabled (using the provider_enable parameter) for this to have any effect.

Basic or advanced: Basic
Range check: enabled / disabled
Default value: disabled
Default value differs with model variant? : N
Config file parameter name: _voip_provider_1.register_enable

VoIP Accounts

VoIP Account Information 1

register domain name

Description:
The IP address or FQDN of the SIP registrar (usually the same as the SIP proxy). Can also include the port number, eg 10.5.150.250:5060.

Basic or advanced: Basic
Range check:

GAI-TRONICS

Default value:
Default value differs with model variant? : N
Config file parameter name: _voip_provider_1.register_domain_name

VoIP Accounts

VoIP Account Information 1

reregister interval

Description:
Sets the default registration update period

Basic or advanced: Advanced
Range check:
Default value: 3600
Default value differs with model variant? : N
Config file parameter name: _voip_provider_1.reregister_interval

VoIP Parameters

Audio settings

voip preferred audio codecs

Description:
Lists the preferred codec types in order of preference when making calls. See section 4.5.1

Basic or advanced: Advanced
Range check: 0 to 63 chars
Default value: 8 0
Default value differs with model variant? : N
Config file parameter name: voip_preferred_audio_codecs

VoIP Parameters

Audio Settings

voip silence suppression enable

Description:
The use of this parameter prevents audio frames from being sent during periods of silence. This reduces the network traffic necessary for making calls.

Basic or advanced: Advanced
Range check: enabled / disabled
Default value: disabled
Default value differs with model variant? : N
Config file parameter name: voip_silence_suppression_enable

VoIP Parameters

Audio Settings

voip dtmf transmit method

Description:
Control for DTMF processing method: 0 = off, 1 = In Band (as audio), 2 = out-of-band (RTP - RFC 2833), 3 = out-of-band (SIP - RFC 2976)

Basic or advanced: Advanced
Range check: 0 to 3
Default value: 0

GAI-TRONICS

Default value differs with model variant? : N
Config file parameter name: voip_dtmf_transmit_method

VoIP Parameters

Audio Settings

voip aec enable

Description:
Enables acoustic echo cancellation

Basic or advanced: Advanced
Range check: enabled / disabled
Default value: disabled
Default value differs with model variant? : Y
Config file parameter name: voip_aec_enable

VoIP Parameters

RTP Protocol Parameters

rtp tos value

Description:
Type of service (TOS) value or Diffserv DSFIELD used for SIP messages as a hexadecimal value

Basic or advanced: Advanced
Range check: 0 to 255
Default value: 0
Default value differs with model variant? : N
Config file parameter name: rtp_tos_value

VoIP Parameters

RTP Protocol Parameters

rtp packet duration

Description:
The duration in msec for frame-based codecs

Basic or advanced: Advanced
Range check: 10 to 500ms
Default value: 30
Default value differs with model variant? : N
Config file parameter name: rtp_packet_duration

VoIP Parameters

RTP Protocol Parameters

rtp stream duration

Description:
The duration in msec for sample stream-based codecs

Basic or advanced: Advanced
Range check: 10 to 500ms
Default value: 20
Default value differs with model variant? : N
Config file parameter name: rtp_stream_duration

GAI-TRONICS

VoIP Parameters

RTP Protocol Parameters

rtp jitter buffer start depth

Description:

Jitter buffer depth at startup in msec

Basic or advanced: Advanced

Range check: 0 to 500ms

Default value: 0

Default value differs with model variant? : N

Config file parameter name: rtp_jitter_buffer_start_depth

VoIP Parameters

RTP Protocol Parameters

rtp jitter buffer minimum depth

Description:

Jitter buffer minimum depth

Basic or advanced: Advanced

Range check: 0 to 500ms

Default value: 0

Default value differs with model variant? : N

Config file parameter name: rtp_jitter_buffer_minimum_depth

VoIP Parameters

RTP Protocol Parameters

rtp jitter buffer skew limit

Description:

Maximum allowable difference (in ms) between an rtp packet's expected and actual receipt times.

Basic or advanced: Advanced

Range check: 0 to 500ms

Default value: 0

Default value differs with model variant? : N

Config file parameter name: rtp_jitter_buffer_skew_limit

VoIP Parameters

Registration Settings

voip multiple registration mode

Description:

If enabled, the unit will register with all enabled providers concurrently. If disabled, it will only attempt to register with a provider in a failover condition. See section 5.

Basic or advanced: Advanced

Range check: enabled / disabled

Default value: Enabled

Default value differs with model variant? : N

Config file parameter name: voip_multiple_registration_mode

GAI-TRONICS

SIP Parameters

SIP Protocol Parameters

sip user agent

Description:

User-Agent header for outbound responses. Factory set to include firmware version.

Basic or advanced: Advanced

Range check: max 95 chars

Default value: GAI-Tronics IP Phone

Default value differs with model variant? : N

Config file parameter name: sip_user_agent

SIP Parameters

SIP Protocol Parameters

sip local port

Description:

Local UDP port used for sending/ receiving SIP call control messages

Basic or advanced: Advanced

Range check: 1024 to 65535

Default value: 5060

Default value differs with model variant? : N

Config file parameter name: sip_local_port

SIP Parameters

SIP Protocol Parameters

sip remote port

Description:

SIP server, with optional port (eg 192.168.1.100:5060). If the port is omitted, the port value from SIP protocol parameters / sip remote port is used.

Basic or advanced: Advanced

Range check: 1024 to 65535

Default value: 5060

Default value differs with model variant? : N

Config file parameter name: sip_remote_port

SIP Parameters

SIP Protocol Parameters

sip tos value

Description:

Type of service (TOS) value or DIFFServ DSFIELD used for SIP messages as a hexadecimal value

Basic or advanced: Advanced

Range check: 0 to 255

Default value: 60

Default value differs with model variant? : N

Config file parameter name: sip_tos_value

GAI-TRONICS

SIP Parameters

SIP Protocol Timers

sip timer no answer duration

Description:

sets the maximum length of time in seconds that the phone will ring on an outgoing call before either failing over to the next in the list or timing out. A value of 0 disables the timer.

Basic or advanced: Advanced

Range check:

Default value: 300

Default value differs with model variant? : N

Config file parameter name: sip_timer_no_answer_duration

SIP Parameters

SIP Protocol Timers

sip session timer

Description:

The amount of time in seconds required for a SIP session to expire if no SIP refresher requests are received

Basic or advanced: Advanced

Range check:

Default value: 1800

Default value differs with model variant? : N

Config file parameter name: sip_session_timer

IPBX Parameters

Call Progress Patterns

ipbx pattern hook

Description:

Set the activation pattern (or cadence) for outputs assigned with the "hook" function. Refer to section 4.5.5

Basic or advanced: Advanced

Range check: max 64 chars

Default value: 1 0

Default value differs with model variant? : N

Config file parameter name: ipbx_pattern_hook

IPBX Parameters

Call Progress Patterns

ipbx pattern ring 1

Description:

Set the activation pattern (or cadence) for outputs assigned with incoming "ring 1" function. Refer to section 4.5.5

Basic or advanced: Advanced

Range check: max 64 chars

Default value: 2 25 25

Default value differs with model variant? : N

Config file parameter name: ipbx_pattern_ring_1

IPBX Parameters

Call Progress Patterns

ipbx pattern ring 2

Description:

Set the activation pattern (or cadence) for outputs assigned with incoming "ring 2" function. Refer to section 4.5.5

Basic or advanced: Advanced

Range check: max 64 chars

Default value: 1 0

Default value differs with model variant? : N

Config file parameter name: ipbx_pattern_ring_2

IPBX Parameters

Call Progress Patterns

ipbx pattern ring out 1

Description:

Set the activation pattern (or cadence) for outputs assigned with outgoing "ring out 1" function. Refer to section 4.5.5

Basic or advanced: Advanced

Range check: max 64 chars

Default value: 2 25 25

Default value differs with model variant? : N

Config file parameter name: ipbx_pattern_ring_out_1

IPBX Parameters

Call Progress Patterns

ipbx pattern ring out 2

Description:

Set the activation pattern (or cadence) for outputs assigned with outgoing "ring out 2" function. Refer to section 4.5.5

Basic or advanced: Advanced

Range check: max 64 chars

Default value: 2 25 25

Default value differs with model variant? : N

Config file parameter name: ipbx_pattern_ring_out_2

IPBX Parameters

Call Progress Patterns

ipbx pattern in use

Description:

Set the activation pattern (or cadence) for outputs assigned with the "in use" function. Refer to section 4.5.5

Basic or advanced: Advanced

Range check: max 64 chars

Default value: 2 25 25

Default value differs with model variant? : N

Config file parameter name: ipbx_pattern_in_use

IPBX Parameters

Call Progress Patterns

ipbx pattern connect

Description:

Set the activation pattern (or cadence) for outputs assigned with the "connect" function. Refer to section 4.5.5

Basic or advanced: Advanced

Range check: max 64 chars

Default value: 1 0

Default value differs with model variant? : N

Config file parameter name: ipbx_pattern_connect

IPBX Parameters

Call Progress Patterns

ipbx pattern registered

Description:

Set the activation pattern (or cadence) for outputs assigned with the "registered" function. Refer to section 4.5.5

Basic or advanced: Advanced

Range check: max 64 chars

Default value: 2 75 75

Default value differs with model variant? : N

Config file parameter name: ipbx_pattern_registered

IPBX Parameters

Call Progress Patterns

ipbx pattern emergency

Description:

Set the activation pattern (or cadence) for outputs assigned with the "emergency" function. Refer to section 4.5.5

Basic or advanced: Advanced

Range check: max 64 chars

Default value: 2 25 25

Default value differs with model variant? : N

Config file parameter name: ipbx_pattern_emergency

IPBX Parameters

Call Progress 1 Information

ipbx call progress 1 priority hook

Description:

Set priority for hook output. There are 6 call progress information pages, with the parameters ipbx_call_progress_1_priority_hook to ipbx_call_progress_6_priority_hook. See section 4.5.5 for full details.

Basic or advanced: Advanced

Range check: max 64 chars

Default value: 0

Default value differs with model variant? : N

GAI-TRONICS

Config file parameter name: ipbx_call_progress_1_priority_hook

IPBX Parameters

Call Progress 1 Information

ipbx call progress 1 priority ring 1

Description:

Set priority for hook output. There are 6 call progress information pages, with the parameters ipbx_call_progress_1_priority_ring_1 to ipbx_call_progress_6_priority_ring_1. See section 4.5.5 for full details.

Basic or advanced: Advanced

Range check: max 64 chars

Default value: 2

Default value differs with model variant? : N

Config file parameter name: ipbx_call_progress_1_priority_ring_1

IPBX Parameters

Call Progress 1 Information

ipbx call progress 1 priority ring 2

Description:

Set priority for hook output. There are 6 call progress information pages, with the parameters ipbx_call_progress_1_priority_ring_2 to ipbx_call_progress_6_priority_ring_2. See section 4.5.5 for full details.

Basic or advanced: Advanced

Range check: max 64 chars

Default value: 0

Default value differs with model variant? : N

Config file parameter name: ipbx_call_progress_1_priority_ring_2

IPBX Parameters

Call Progress 1 Information

ipbx call progress 1 priority ring out 1

Description:

Set priority for hook output. There are 6 call progress information pages, with the parameters ipbx_call_progress_1_priority_ring_out_1 to ipbx_call_progress_6_priority_ring_out_1. See section 4.5.5 for full details.

Basic or advanced: Advanced

Range check: max 64 chars

Default value: 2

Default value differs with model variant? : N

Config file parameter name: ipbx_call_progress_1_priority_ring_out_1

IPBX Parameters

Call Progress 1 Information

ipbx call progress 1 priority ring out 2

Description:

Set priority for hook output. There are 6 call progress information pages, with the parameters ipbx_call_progress_1_priority_ring_out_2 to ipbx_call_progress_6_priority_ring_out_2. See section 4.5.5 for full details.

GAI-TRONICS

Basic or advanced: Advanced
Range check: max 64 chars
Default value: 0
Default value differs with model variant? : N
Config file parameter name: ipbx_call_progress_1_priority_ring_out_2

IPBX Parameters

Call Progress 1 Information

ipbx call progress 1 priority in use

Description:
Set priority for hook output. There are 6 call progress information pages, with the parameters ipbx_call_progress_1_priority_in_use to ipbx_call_progress_6_priority_in_use. See section 4.5.5 for full details.

Basic or advanced: Advanced
Range check: max 64 chars
Default value: 3
Default value differs with model variant? : N
Config file parameter name: ipbx_call_progress_1_priority_in_use

IPBX Parameters

Call Progress 1 Information

ipbx call progress 1 priority connect

Description:
Set priority for hook output. There are 6 call progress information pages, with the parameters ipbx_call_progress_1_priority_connect to ipbx_call_progress_6_priority_connect. See section 4.5.5 for full details.

Basic or advanced: Advanced
Range check: max 64 chars
Default value: 1
Default value differs with model variant? : N
Config file parameter name: ipbx_call_progress_1_priority_connect

IPBX Parameters

Call Progress 1 Information

ipbx call progress 1 priority registered

Description:
Set priority for hook output. There are 6 call progress information pages, with the parameters ipbx_call_progress_1_priority_registered to ipbx_call_progress_6_priority_registered. See section 4.5.5 for full details.

Basic or advanced: Advanced
Range check: max 64 chars
Default value: 0
Default value differs with model variant? : N
Config file parameter name: ipbx_call_progress_1_priority_registered

IPBX Parameters

Call Progress 1 Information

ipbx call progress 1 priority emergency

Description:

GAI-TRONICS

Set priority for hook output. There are 6 call progress information pages, with the parameters `ipbx_call_progress_1_priority_emergency` to `ipbx_call_progress_6_priority_emergency`. See section 4.5.5 for full details.

Basic or advanced: Advanced

Range check: max 64 chars

Default value: 0

Default value differs with model variant? : N

Config file parameter name: `ipbx_call_progress_1_priority_emergency`

IPBX Parameters

Timers

ipbx initial dial duration

Description:

Specifies amount of time (in units of 10 msec) for the user to dial a digit after picking up the telephone receiver.

Basic or advanced: Advanced

Range check: 0 to 65535

Default value: 1500

Default value differs with model variant? : N

Config file parameter name: `ipbx_initial_dial_duration`

IPBX Parameters

Timers

ipbx hangup silence duration

Description:

If the remote party hangs up during a call, the call disconnect tone will play for this period of time (in units of 10ms). Following this, the reorder tone will play for a duration of `ipbx_timeout_tone_duration` (see below)

Basic or advanced: Advanced

Range check: 0 to 65535

Default value: 1000

Default value differs with model variant? : N

Config file parameter name: `ipbx_hangup_silence_duration`

IPBX Parameters

Timers

ipbx timeout tone duration

Description:

Specifies the period of time (in units of 10ms) that a reorder tone will play for if a timeout occurs during dialing or answering. A setting of zero will cause the reorder tone to be played out forever.

Basic or advanced: Advanced

Range check: 0 to 65535

Default value: 5000

Default value differs with model variant? : N

Config file parameter name: `ipbx_timeout_tone_duration`

IPBX Parameters

Timers

GAI-TRONICS

ipbx timeout no answer drop duration

Description:

Sets the maximum time in seconds that the phone will ring on an incoming call before ending it. A value of 0 disables the timer, meaning that the phone will ring until answered or the call is ended either by the caller or the server.

Basic or advanced: Advanced

Range check: 0 to 65535

Default value: 0

Default value differs with model variant? : N

Config file parameter name: ipbx_timeout_no_answer_drop_duration

Regionalisation

Call Progress Tones

ipbx_initial_dial_tone

Description:

Normal dial tone pattern. See code explanations, section 4.5.8.

Basic or advanced: Advanced

Range check:

Default value: 2 0 0 350 -19 400 -19

Default value differs with model variant? : N

Config file parameter name: ipbx_initial_dial_tone_

Regionalisation

Call Progress Tones

ipbx_pre_ringback tone

Description:

Pre-ringback tone pattern sequence. See code explanations, section 4.5.8.

Basic or advanced: Advanced

Range check:

Default value: 4 -8 0 440 -16 494 -19 523 -19 587 -19 340 160 340 160 340 160

Default value differs with model variant? : N

Config file parameter name: ipbx_pre_ringback_tone

Regionalisation

Call Progress Tones

ipbx ringback tone

Description:

Ringback composite tone pattern. See code explanations, section 4.5.8.

Basic or advanced: Advanced

Range check:

Default value: 2 4 0 400 -19 450 -19 400 200 400 2000

Default value differs with model variant? : N

Config file parameter name: ipbx_ringback_tone

Regionalisation

Call Progress Tones

ipbx call disconnect tone

GAI-TRONICS

Description:

Call disconnect tone pattern. See code explanations, section 4.5.8.

Basic or advanced: Advanced

Range check:

Default value: 2 2 0 480 -19 620 -19 500 500

Default value differs with model variant? : N

Config file parameter name: ipbx_call_disconnect_tone

Regionalisation

Call Progress Tones

ipbx busy tone

Description:

Normal busy composite tone pattern. See code explanations, section 4.5.8.

Basic or advanced: Advanced

Range check:

Default value: 1 2 0 400 -19 375 375

Default value differs with model variant? : N

Config file parameter name: ipbx_busy_tone

Regionalisation

Call Progress Tones

ipbx reorder tone

Description:

Re-order (network/fast busy) composite tone pattern. See code explanations, section 4.5.8.

Basic or advanced: Advanced

Range check:

Default value: 1 4 0 400 -19 400 350 225 525

Default value differs with model variant? : N

Config file parameter name: ipbx_reorder_tone

Regionalisation

Call Progress Tones

ipbx off hook warning tone

Description:

Off-hook warning composite tone pattern. See code explanations, section 4.5.8.

Basic or advanced: Advanced

Range check:

Default value: 4 2 0 1400 11 2050 11 2450 11 2600 11 100 100

Default value differs with model variant? : N

Config file parameter name: ipbx_off_hook_warning_tone

Regionalisation

Call Progress Tones

ipbx call ring default tone

Description:

Default ring tone pattern. See code explanations, section 4.5.8.

GAI-TRONICS

Basic or advanced: Advanced
Range check:
Default value: 2 4 0 3380 -10 20 -10 400 200 400 2000
Default value differs with model variant? : Y
Config file parameter name: ipbx_call_ring_default_tone

User Configuration

Speed Dials

ipbx speed dial [1-20]

Description:
Speed dial entries. Up to 20 entries can be stored, ipbx_speed_dial_1 to
_ipbx_speed_dial_20

Basic or advanced: Basic
Range check: max 48 chars
Default value:
Default value differs with model variant? : N
Config file parameter name: ipbx_speed_dial_1

User Configuration

Speed Dials

ipbx speed dial group array

Description:
Defines memory dial and failover functionality, see code explanations, section
4.5.3

Basic or advanced: Basic
Range check: max 60 chars
Default value: 1 2 3 0 0 0 0 0 0 0 0 0 0 0 0 0 0 0 0 0
Default value differs with model variant? : Y
Config file parameter name: ipbx_speed_dial_group_array

Phone Configuration

Phone Parameters

ipbx blind transfer mode

Description:
Sets the blind transfer mode to be either 0 (Immediate), 1 (Ringback) or 2
(Answered)

Basic or advanced: Basic
Range check: 0 to 2
Default value: 2
Default value differs with model variant? : N
Config file parameter name: ipbx_blind_transfer_mode

Phone Configuration

Phone Parameters

phone autoanswer mode

Description:

GAI-TRONICS

Controls the automatic answering of the phone for an incoming call: 0 = Off / 1 = Preceding Tone / 2 = Silent Answer / 3 = Babyphone mode / 4 = Page Mode. See section 3.1

Basic or advanced: Basic
Range check: 0 to 4
Default value: 0
Default value differs with model variant? : Y
Config file parameter name: phone_autoanswer_mode

Phone Configuration

Phone Parameters

phone autoanswer ring count

Description:

If "Preceding Tone" or "Page Mode" is selected, this sets how many rings (of the default ring tone) before the phone auto answers. If the ring tone is a continuous tone, this sets the duration in units of 10ms

Basic or advanced: Basic
Range check: 0 to 65535
Default value: 1
Default value differs with model variant? : Y
Config file parameter name: phone_autoanswer_ring_count

Phone Configuration

Phone Parameters

max call duration

Description:

Maximum call duration in seconds. Any active call will automatically terminate after this period. 0 will prevent automatic termination.

Basic or advanced: Basic
Range check: 0 to 65535
Default value: 14400
Default value differs with model variant? : N
Config file parameter name: max_call_duration

Phone Configuration

Phone Audio Settings

audio device channel

Description:

0 for handsfree, 1 for handset.

Basic or advanced: Basic
Range check: 0 or 1
Default value: 1
Default value differs with model variant? : Y
Config file parameter name: audio_device_channel

Phone Configuration

Phone Audio Settings

handset volume

GAI-TRONICS

Description:

For products with a handset, modifies the earpiece level in 10 steps, where each step is approx 2dB. If the product has a volume step control, this sets its starting point for each new call. Normally leave at default.

Basic or advanced: Basic

Range check: 0 to 9

Default value: 4

Default value differs with model variant? : N

Config file parameter name: handset_volume

Phone Configuration

Phone Audio Settings

speakerphone volume

Description:

For Help Point or handsfree products, modifies the speaker output level in 10 steps, where each step is approx 2dB. If the product has a volume step control, this sets its starting point for each new call. Normally leave at default.

Basic or advanced: Basic

Range check: 0 to 9

Default value: 4

Default value differs with model variant? : N

Config file parameter name: speakerphone_volume

Phone Configuration

Phone Audio Settings

ringer volume

Description:

Modifies the ringer level in 10 steps, where each step is approx 2dB.

Basic or advanced: Basic

Range check: 0 to 9

Default value: 8

Default value differs with model variant? : Y

Config file parameter name: ringer_volume

Phone Configuration

Phone Audio Settings

sidetone

Description:

Enable or disable sidetone for handset telephones

Basic or advanced: Basic

Range check: enabled / disabled

Default value: Enabled

Default value differs with model variant? : Y

Config file parameter name: sidetone

Phone Configuration

Phone Audio Settings

sidetone level

GAI-TRONICS

Description:

Sets level of sidetone, if enabled. Range is 0 to 128, where 0 is the loudest setting.

Basic or advanced: Basic

Range check: 0 to 128

Default value: 0

Default value differs with model variant? : N

Config file parameter name: sidetone_level

Phone Configuration

Phone Audio Settings

headset mic gain

Description:

Auteldac 6 only - headset mic gain

Basic or advanced: Basic

Range check: -20 to +20 dB

Default value: 5

Default value differs with model variant? : N

Config file parameter name: headset_mic_gain

Phone Configuration

Phone Audio Settings

headset volume

Description:

Auteldac 6 only - headset earpiece volume

Basic or advanced: Basic

Range check: 0 to 9

Default value: 6

Default value differs with model variant? : N

Config file parameter name: headset_volume

Phone Configuration

Phone Audio Settings

headset sidetone level

Description:

Auteldac 6 only - headset sidetone level

Basic or advanced: Basic

Range check: 0 to 128

Default value: 0

Default value differs with model variant? : N

Config file parameter name: headset_sidetone_level

4.5 Code string explanations

Some of the parameters listed above are defined by code strings. The rules and construction of these strings are described below

IMPORTANT: Ensure there are no leading spaces at the start of any code string.

GAI-TRONICS

4.5.1 Codecs

There are 3 audio codecs available, coded as follows:

G.711a = 8

G.711u = 0

G.729 = 18

Codecs required are entered in the desired preference order, separated by spaces.

For example, to use G.711a as the 1st preference and G.711u as the 2nd preference, the string should be entered as just:

8 0

4.5.2 Button map string

The button map string defines the functions of all available pushbuttons and keypad keys, plus the 4 logic inputs and the hookswitch.

The maximum number of pushbuttons or keypad keys is 18, so with the 4 inputs and the hookswitch there are 23 inputs which can be defined.

The button map string therefore consists of 23 codes separated by spaces.

IMPORTANT: Ensure there are no leading spaces at the start of the string.

The position of each code within the string maps it to a button or input. In other words the first code defines the function of button 1, the second code defines button 2 and so on. The final (23rd) code defines the function of the hookswitch.

The buttons/inputs are (In order):

[1 - 18]: Keypad buttons, see diagrams below.

[19 - 22]: External inputs 1 - 4

[23]: Hook switch

The physical locations of the buttons on different models of telephone are shown in the following tables:

Auteldac 6, Titan and Commander (keypad) models - button positions viewed from front		
1	2	3
4	5	6
7	8	9
10	11	12
13	14	15
16	17	18

Help Point models - button map string position identifiers		
1 button	2 button	3 button
4	4	4
	18	18
		11

Other inputs - button map string position identifiers	
Logic input 1	19
Logic input 2	20
Logic input 3	21
Logic input 4	22
Hookswitch	23

Sentinel (Handsfree with 4x4 keypad) – button positions viewed from the front			
18	15	17	
12	9	6	3
14	11	8	5

(note the top right button cannot be assigned)

GAI-TRONICS

16	13	10	7
----	----	----	---

Each assigned code consists of 1 or more text characters defined below

Each button or input may have one of the following functions:

- 0 - None
- 1 - Digit
- 2 - Memory dial
- 3 - PTT / mute (*see important note below*)
- 4 - Redial
- 5 - Volume
- 6 - Hook
- 7 - Hook HF
- 8 - Memory Hook

The following modifiers may be applied to appropriate buttons and or input function codes; note that all letters are lower case:

m# (where # is a number between 1 and 29) - sets the memory number for button/input function 2 or 8. For example, 2m1 sets it to memory 1. A memory is defined as a group of one or more speed dials; memory numbers refer to entries in the speed dial group array (see section 4.5.3 below).

p# (where # is a number between 0 and 3) - sets the call priority for a memory button. For example, 2m1p1 will set a button to be memory 1 with a priority of 1. Higher numbers have higher priority. Default (if left out) is zero. Any memory button set with a priority >0 can activate the "emergency" call progress state (see section 4.5.5)

l (lower case L) - Prevent local disconnect. If this is set, pressing the button while in a call will not hang up. For example 2m1l will set a button to start a call by dialling memory 1, but pressing the button a second time will not terminate the call.

cx where **x** is a digit between 0 and 9, or a "#" or "*" character - sets the digit that will be dialled for button function 1. For example, 1c9 will cause a button to dial digit 9; 1c* will make it dial a "*" character.

Important note regarding PTT / mute. Button function 3 (PTT/ mute) is a press-and-hold function which can have one of 2 operations, depending on the setting of the "ptt mode enabled" parameter. If ptt is enabled, it will operate as a push-to-talk button (press and hold the button to activate the microphone, release to mute). If it is disabled it will act as a mute button (press and hold to mute the microphone, release to talk). Do not enable PTT mode if there is no button defined with function 3. If PTT is enabled, but there is no PTT button defined, the telephone microphone will be permanently muted.

Notes:

For Titan and Commander (keypad) models, the diagram represents all the possible button positions; 18-button variants use all of these positions, but other variants use a subset. For example, a 6-button variant, having a vertical column of buttons on the left-hand side, would only use button positions 1, 4, 7, 10, 13 & 16.

For Help Points, the default configuration is that all pushbuttons are memory buttons - a single button variant would use only position 4, a 2 button variant would have position 4 for the upper button and 18 for the lower, a 3 button variant would have position 4 at the top, position 18 in the middle and 11 at the bottom.

Any unused buttons or inputs can be coded as 0.

The default button map strings for standard phone types are shown below

Phone Type	Button map string
Titan / Commander 18 button	2m1 2m2 2m3 1c1 1c2 1c3 1c4 1c5 1c6 1c7 1c8 1c9 1c* 1c0 1c# 5 0 4 0 0 0 0 6

GAI-TRONICS

Phone Type	Button map string
Titan / Commander 6 button	2m1 0 0 2m2 0 0 2m3 0 0 2m4 0 0 2m5 0 0 2m6 0 0 0 0 0 0 6
Titan / Commander 0 button	0 8m1
Titan Illuminated Crossing Phone	0 0 0 2m1 0 0 0 0 0 0 0 0 0 0 0 0 0 0 0 0 0 6
VR 1-3 button, no priority	0 0 0 2m1 0 0 0 0 0 0 2m3 0 0 0 0 0 0 2m2 0 0 0 0 0
Help Point 2 button, priority on lower button	0 0 0 2m1l 0 0 0 0 0 0 0 0 0 0 0 0 0 0 2m2p1l 0 0 0 0 0
PHP Help Point, priority on upper button	0 0 0 2m1p1l 0 0 0 0 0 0 0 0 0 0 0 0 0 0 2m2l 0 0 0 0 0
Clean Phone	7 2m1 1c3 2m2 1c2 1c6 1c1 1c5 1c9 1c4 1c8 1c# 1c7 1c0 0 1c* 2m3 0 0 0 0 0 0
Sentinel (Handsfree 16 button full dialler)	0 0 5 0 2m1 1c6 7 1c9 1c5 1c# 1c8 1c4 1c0 1c7 1c2 1c* 1c3 1c1 0 0 0 0 0
Auteldac 6 (Headset not enabled)	2m1 2m2 2m3 1c1 1c2 1c3 1c4 1c5 1c6 1c7 1c8 1c9 1c* 1c0 1c# 5 0 4 0 0 0 0 6

4.5.3 Speed dial group array

This array controls which speed dial entries are invoked by which memories. A memory is defined as a group of one or more speed dials. Memories are assigned by the “m” modifier in the button map string (section 4.5.2 above). For example, 2m1 assigns a button or input to be memory 1.

Speed dial entries are listed on the speed dials page - up to 20 can be entered.

The speed dial group array is a list of 20 numbers separated by spaces. The position of a number in the list maps it to the speed dial entry - i.e. the first number in the list corresponds to speed dial 1, the second to speed dial 2 and so on up to the 20th.
IMPORTANT: Ensure there are no leading spaces at the start of the array.

Each number in the list represents the memory which will invoke that speed dial.

Take for example the following array:
1 2 3 3 0 0 0 0 0 0 0 0 0 0 0 0 0 0 0 0

Note that the number 3 occurs twice.

The first number in the array is 1, meaning that memory 1 will dial speed dial 1. The second number is 2 - memory 2 will dial speed dial 2. The third number is 3, meaning that memory 3 will dial speed dial 3.

The fourth number is also 3, meaning that memory 3 can also dial speed dial 4. If memory 3 is activated, the phone will first dial speed dial 3; if the call fails, it will then dial speed dial 4. When a memory is activated, the telephone works through the array from left to right. If it finds a match for the memory number, it will attempt to dial the speed dial corresponding to the position in the array. If the call fails, it will continue along the array to find another match and attempt to call that speed dial, and so on until either the call succeeds or there are no more matches.

Speed dials which are not used should be set to 0 in the array.

Note that, because the telephone reads the array from left to right, if speed dials are used in a failover sequence as described above, the speed dial entries must be in the same order as the sequence.

Example:

1 1 1 2 2 2 3 3 3 4 4 4 4 0 0 0 0 0 0

GAI-TRONICS

In this example, a button (or input) assigned as memory 1 will first attempt to call speed dial 1. If that fails, it will attempt speed dial 2; if that fails speed dial 3 and if that fails it will abandon the call.

A button assigned as memory 2 will act similarly using speed dials 4, 5 and 6.

A button assigned as memory 3 will act similarly using speed dials 7, 8 and 9.

A button assigned as memory 4 will act similarly, but using five speed dials: 10, 11, 12, 13 and 14.

In this example, speed dials 15 - 20 are not assigned.

4.5.4 LED / Relay map string

This string controls the display function of 4 LEDs, 2 relays and 2 logic outputs, i.e. 8 outputs in total.

Note that not all of these outputs are present on all models - refer to product specifications for details.

The LED relay map string is a series of 8 codes, each code representing the function of a single output, each code separated from the next by a space. The position of the code within the string defines which input it is for.

IMPORTANT: Ensure there are no leading spaces at the start of the string.

The outputs are (In order):

Position 1: LED 0 - not normally fitted

Positions 2 - 4: LEDs 1 - 3 (only normally available in Help Point products, usually only LED1 is fitted)

Positions 5 - 6: Relays 1 & 2 (usually fitted to all products, except Auteldac 6 which only includes Relay 1)

Position 7: LED power select (normally set to OFF. Only enabled for products requiring a higher LED drive voltage. Refer to GAI-Tronics for details)

Position 8: Audio present (normally set to OFF. Only enabled for products requiring an audio enable output. Refer to GAI-Tronics for details)

The function of each output is defined by 1 text character, separated from the next output by a space.

The following lists all supported functions:

0 = Always Off

1 = Call Progress 1

2 = Call Progress 2

3 = Call Progress 3

4 = Call Progress 4

5 = Call Progress 5

6 = Call Progress 6

9 = Always ON

Where "Call Progress x" refers to the settings on the appropriate call progress information page, in the IPBX Parameters section. See section 4.5.5 below.

Example: 0 1 0 0 2 3 0 0

LED1 is controlled by the settings on the call progress 1 information page, LEDs 0, 2 and 3 are off, relay 1 is controlled the settings on the call progress 2 information page, relay 2 is controlled the settings on the call progress 3 information page, LED power select and audio present outputs are off.

4.5.5 Call progress patterns and priorities

LEDs and relays can be configured to activate during various stages of telephone call progress. For example, an LED could be set to indicate that a call is connected, or a relay could be set to activate when an incoming call is ringing.

Additionally, a single output can be set to indicate different stages of call progress. For example, the same LED could be set to flash when a call is ringing but illuminate steadily when the call connects.

GAI-TRONICS

These options are set using 2 groups of settings:

- **Patterns**, on the IPBX Parameters / Call Progress Patterns page, where each stage of call progress is assigned a pattern or cadence, and
- **Priorities**, on the IPBX Parameters / Call Progress information pages, where patterns are assigned to outputs with a priority sequence. This means that a single output could be set to indicate more than one call progress stage or status: the priority settings clarify which takes precedence. For example an LED could be set to indicate both "in use" and "emergency", with different flashing patterns for each. The priority could be set so that the "emergency" pattern takes precedence.

The call progress and other statuses that can activate outputs are:

- **Hook** - activates when the telephone is off hook - either when preparing to start a call, when an outgoing call is ringing or when a call is active.
- **Ring 1 / Ring 2** - when an incoming call is ringing but not yet answered. There are 2 patterns available to allow different patterns to be set up for different outputs. For example, an LED could be set to flash and a relay could be set to activate continuously during ringing.
- **Ring out 1 / Ring out 2** - when an outgoing call is ringing but not yet answered. There are 2 patterns available to allow different patterns to be set up for different outputs. For example, an LED could be set to flash and a relay could be set to activate continuously during ringing.
- **In use** - activates when the telephone is either ringing or in a call
- **Connect** - activates only while a call is connected.
- **Registered** - activates when the telephone is registered with at least one provider.
- **Emergency** - activates when an outgoing emergency call is either ringing or connected. An emergency call is defined as a call initiated by a button set with a priority >0 (see section 4.5.2)

Call progress patterns are specified by a list of values indicating the number of on/off transitions and display on/off times (in units of 10ms) according to the following format:

N ON₁ OFF₁ ON₂ OFF₂ ... ON_N OFF_N

Where N is the number of on and off transitions counted individually in the pattern, ON_x and OFF_x are interleaved on and off durations in units of 10ms.

Values are separated by spaces.

N may be zero for a permanently off or unused status.

A value of zero for an on time indicates continuously on. A value of zero for an off time turns the output continuously off.

The maximum number of on and off times counted individually is 9.

For example, to turn an output constantly on, the pattern would be just 1 0.

To flash an output on and off every half-second, the pattern would be 2 50 50.

Priorities are set on one of 6 call progress information pages.

A call progress information page can be assigned to one or more outputs as described in section 4.5.4 above.

Within each call progress information page, each function is turned on by assigning a priority value > zero (ie functions are disabled by setting their priority to zero).

To activate a single function, set its value to 1 and all the others to zero.

To give an output multiple functions, give each function a non-zero priority number where 1 is the highest priority, 2 the next highest and so on.

The example below shows an output set to activate during ring (pattern 1) only:

IPBX Parameters	Call Progress 1 Information	
Call Progress Patterns		
Call Progress 1 Information	ipbx call progress 1 priority hook	<input type="text" value="0"/>
Call Progress 2 Information	ipbx call progress 1 priority ring 1	<input type="text" value="1"/>
Call Progress 3 Information	ipbx call progress 1 priority ring 2	<input type="text" value="0"/>
Call Progress 4 Information	ipbx call progress 1 priority ring out 1	<input type="text" value="0"/>
Call Progress 5 Information	ipbx call progress 1 priority ring out 2	<input type="text" value="0"/>
Call Progress 6 Information	ipbx call progress 1 priority in use	<input type="text" value="0"/>
Timers	ipbx call progress 1 priority connect	<input type="text" value="0"/>
	ipbx call progress 1 priority registered	<input type="text" value="0"/>
	ipbx call progress 1 priority emergency	<input type="text" value="0"/>

The example below shows an output set to activate during ring (pattern 2), or when a call is connected, or when the telephone is registered.

IPBX Parameters	Call Progress 2 Information	
Call Progress Patterns		
Call Progress 1 Information	ipbx call progress 2 priority hook	<input type="text" value="0"/>
Call Progress 2 Information	ipbx call progress 2 priority ring 1	<input type="text" value="0"/>
Call Progress 3 Information	ipbx call progress 2 priority ring 2	<input type="text" value="1"/>
Call Progress 4 Information	ipbx call progress 2 priority ring out 1	<input type="text" value="0"/>
Call Progress 5 Information	ipbx call progress 2 priority ring out 2	<input type="text" value="0"/>
Call Progress 6 Information	ipbx call progress 2 priority in use	<input type="text" value="0"/>
Timers	ipbx call progress 2 priority connect	<input type="text" value="2"/>
	ipbx call progress 2 priority registered	<input type="text" value="3"/>
	ipbx call progress 2 priority emergency	<input type="text" value="0"/>

In this example, if the phone is ringing, then the pattern assigned for “ring2” will be used as the priority. If the phone is not ringing but the call is connected, then the pattern for “connect” will be used. If the phone is neither ringing nor in a connected call, but is still registered, the pattern for “registered” will be used. In this way, by setting distinctive patterns, the phone can use a single output to indicate multiple states.

If an output is used to indicate multiple functions, each function should be given a different priority number. If two or more functions have the same priority number, the telephone will prioritise them in the order in which they appear on the web page from top to bottom.

4.5.6 Input pattern

The input pattern string allows rules to be set up governing which numbers and sequences can be dialled when using a numeric keypad.

This can be used for example to limit the number of digits that can be entered, or to prohibit certain numbers being dialled, or to enable a termination character.

The default setting is **e*e#~+** , meaning that the user can enter up to 255 digits, terminated with either # or *.

IMPORTANT: Ensure there are no leading spaces at the start of the string.

GAI-TRONICS

The full set of characters used to build input pattern rules is set out below (note that all letters are lower case)

Parameter	Description
"e"	specify ending termination digit which follows (usually * or #). Note, if used, this parameter must occur first in any rule pattern
"t"	set digit timeout to default (5 seconds) for current pattern
"x"	match any numerical digit (0-9). Note that including x in a rule pattern will cause dialling to abort if either "*" or "#" are dialled.
"~"	match any digit (0-9, A-D, *, #) excluding any specified terminators
"r"	repeat by following a number (1-9), letter (a-z for 10 to 35 times) or "*", "+" or "." to mean any number of times (255 times)
."	repeat previous digit any number of times (0 to 255)
"+"	repeat previous digit any number of times (0 to 255)
"!"	disallows pattern
"\$"	indicates secondary dialling to follow - used only by fixed dial strings
"<:>"	replace group to replace left digit(s) with right digit(s)
"[]"	selection group of candidate digits
"[^]"	exclusion group of digits
"[0-9]"	selection range of candidate numerical digits
"[a-d]"	selection range of candidate letter digits
"s"	seize on string as only candidate if match to this point
"f"	pause timeout causes failure instead of dial
"p"	set digit pause to number of seconds which follow (1-9) for current pattern
"_"	human readable spacing which is ignored
" "	human readable spacing which is ignored
" "	separates different possible rule patterns

The input pattern string can consist of a number of different rules, separated by the | character, example:

6xr4|60600! - allows any 5 digit number starting with 6, except 60600.

Note that including "~+" (which allows up to 255 unrestricted digits), in conjunction with any other rule which restricts the number or type of digits allowed, may cause a conflict with unexpected results.

The input pattern rules do not apply to memory dials.

4.5.7 Fault mask codes

Fault mask codes, together with the various available fault reporting mechanisms, are described in section 10.

4.5.8 Ring Tones / Call Progress Tones

Ring and call progress tones are specified by a list of values indicating frequencies and timings. The system gives a high level of flexibility and control over tone generation. For simplicity, best approximations of various call progress and ring tones matching those commonly used in various countries are tabulated below.

GAI-TRONICS

The full rules for specifying custom tones are presented below these tables.

These coding rules apply to all the possible tones on the Call Progress Tones page.

Note that “ring tones” are tones made by the telephone on an incoming ring, whereas “ringback tone” is the sound the user hears when an outgoing call is ringing.

On handsfree telephone (for example Help Points) the ring tones are played from the telephone’s integral speaker and can therefore be set to include a fairly wide range of frequencies. On handset telephones, such as Titan and Commander models, the ring tones are played via a dedicated, high loudness piezo sounder, which will give a far louder ring if the ring tones are set to certain resonant frequencies. These will be factory set for the appropriate model, but are listed in the regional examples below.

IMPORTANT: Ensure there are no leading spaces at the start of any string.

4.5.8.1 Suggested tone settings (UK)

Tone	String
Initial dial tone	2 0 0 350 -19 400 -19
Pre ringback tone	4 -8 0 440 -16 494 -19 523 -19 587 -19 340 160 340 160 340 160 340 160
Ringback tone	2 4 0 400 -19 450 -19 400 200 400 2000
Call disconnect tone	2 2 0 480 -19 620 -19 500 500
Busy tone	1 2 0 400 -19 375 375
Reorder tone	1 4 0 400 -19 400 350 225 525
Off hook warning tone	4 2 0 1400 11 2050 11 2450 11 2600 11 100 100
Number error tone	1 0 0 400 -19
Key confirmation tone	1 2 0 620 -16 100 0
Default ring tone (Handsfree)	2 4 0 1000 -10 20 -10 400 200 400 2000
Default ring tone (Titan)	2 4 0 3380 -10 20 -10 400 200 400 2000
Default ring tone (Commander)	2 4 0 2750 -10 20 -10 400 200 400 2000
Default ring tone (Auteldac 6)	2 4 0 3250 -1 3300 -1 400 200 400 2000

4.5.8.2 Suggested tone settings (US)

Tone	String
Initial dial tone	2 0 0 350 -19 400 -19
Pre ringback tone	4 -8 0 440 -16 494 -19 523 -19 587 -19 340 160 340 160 340 160 340 160
Ringback tone	2 2 0 400 -19 450 -19 2000 4000
Call disconnect tone	2 2 0 480 -19 620 -19 500 500
Busy tone	2 2 0 480 -19 620 -19 500 500
Reorder tone	2 2 0 480 -19 620 -19 250 250
Off hook warning tone	4 2 0 1400 11 2050 11 2450 11 2600 11 100 100
Number error tone	1 0 0 400 -19
Key confirmation tone	1 2 0 620 -16 100 0
Default ring tone (Handsfree)	2 2 0 1000 -10 20 -10 2000 4000
Default ring tone (Titan)	2 2 0 3380 -10 20 -10 2000 4000
Default ring tone (Commander)	2 2 0 2750 -10 20 -10 2000 4000
Default ring tone (Auteldac 6)	2 2 0 3250 -1 3300 -1 2000 4000

GAI-TRONICS

4.5.8.3 Suggested tone settings (France)

Tone	String
Initial dial tone	1 0 0 440 -19
Pre ringback tone	4 -8 0 440 -16 494 -19 523 -19 587 -19 340 160 340 160 340 160 340 160
Ringback tone	1 2 0 440 -19 450 -19 1500 3500
Call disconnect tone	2 2 0 480 -19 620 -19 500 500
Busy tone	2 2 0 440 -19 450 -19 500 500
Reorder tone	2 2 0 440 -19 450 -19 500 500
Off hook warning tone	4 2 0 1400 11 2050 11 2450 11 2600 11 100 100
Number error tone	2 2 0 440 -19 450 -19 500 100
Key confirmation tone	1 2 0 620 -16 100 0
Default ring tone (Handsfree)	2 2 0 1000 -10 20 -10 1500 3500
Default ring tone (Titan)	2 2 0 3380 -10 20 -10 1500 3500
Default ring tone (Commander)	2 2 0 2750 -10 20 -10 1500 3500
Default ring tone (Auteldac 6)	2 2 0 3250 -1 3300 -1 1500 3500

4.5.8.4 Suggested tone settings (Netherlands)

Tone	String
Initial dial tone	1 0 0 425 -19
Pre ringback tone	4 -8 0 440 -16 494 -19 523 -19 587 -19 340 160 340 160 340 160 340 160
Ringback tone	1 2 0 425 -19 1000 4000
Call disconnect tone	2 2 0 480 -19 620 -19 500 500
Busy tone	1 2 0 425 -19 475 475
Reorder tone	1 2 0 425 -19 250 250
Off hook warning tone	4 2 0 1400 11 2050 11 2450 11 2600 11 100 100
Number error tone	1 2 0 425 -19 1000 100
Key confirmation tone	1 2 0 620 -16 100 0
Default ring tone (Handsfree)	2 2 0 1000 -10 20 -10 1000 4000
Default ring tone (Titan)	2 2 0 3380 -10 20 -10 1000 4000
Default ring tone (Commander)	2 2 0 2750 -10 20 -10 1000 4000
Default ring tone (Auteldac 6)	2 2 0 3250 -1 3300 -1 1000 4000

4.5.8.5 Suggested tone settings (Portugal)

Tone	String
Initial dial tone	1 0 0 400 -19
Pre ringback tone	4 -8 0 440 -16 494 -19 523 -19 587 -19 340 160 340 160 340 160 340 160
Ringback tone	1 2 0 400 -19 1000 5000
Call disconnect tone	2 2 0 480 -19 620 -19 500 500
Busy tone	1 2 0 400 -19 500 500
Reorder tone	1 2 0 400 -19 500 500
Off hook warning tone	4 2 0 1400 11 2050 11 2450 11 2600 11 100 100
Number error tone	1 2 0 425 -19 200 200
Key confirmation tone	1 2 0 620 -16 100 0
Default ring tone (Handsfree)	2 2 0 1000 -10 20 -10 1000 5000
Default ring tone (Titan)	2 2 0 3380 -10 20 -10 1000 5000

GAI-TRONICS

Tone	String
Default ring tone (Commander)	2 2 0 2750 -10 20 -10 1000 5000
Default ring tone (Auteldac 6)	2 2 0 3250 -1 3300 -1 1000 5000

4.5.8.6 Suggested tone settings (Norway)

Tone	String
Initial dial tone	1 0 0 425 -19
Pre ringback tone	4 -8 0 440 -16 494 -19 523 -19 587 -19 340 160 340 160 340 160
Ringback tone	1 2 0 425 -19 1000 4000
Call disconnect tone	2 2 0 480 -19 620 -19 500 500
Busy tone	1 2 0 425 -19 500 500
Reorder tone	1 2 0 425 -19 250 250
Off hook warning tone	4 2 0 1400 11 2050 11 2450 11 2600 11 100 100
Number error tone	1 0 0 425 -19
Key confirmation tone	1 2 0 620 -16 100 0
Default ring tone (Handsfree)	2 2 0 1000 -10 20 -10 2000 4000
Default ring tone (Titan)	2 2 0 3380 -10 20 -10 2000 4000
Default ring tone (Commander)	2 2 0 2750 -10 20 -10 2000 4000
Default ring tone (Auteldac 6)	2 2 0 3250 -1 3300 -1 2000 4000

4.5.8.7 Parameters for specifying custom call progress tones.

Ring and call progress tones are specified by a list of values indicating the number of tones, number of on/off transitions, frequency/signal level pairs and tone on/off times according to the following format:

T N D F₁ L₁ ... F_N L_N ON₁ OFF₁ ... ON_N OFF_N

Parameters are separated by spaces.

T is the number of tones consisting of a frequency, dB pair. Up to four tones may be combined together to form a composite tone or played in sequence. A negative sign number means to synchronize to the timing epoch (2 or 6 seconds).

N is the number of on and off transitions counted individually in the tone pattern. This number is positive to produce a composite tone or negative to output one tone at a time in sequence and may be zero for a continuous composite tone.

D is the duration in seconds to play the call progress tone. A value of zero means until instructed otherwise.

F and L represents the frequency (Hz) and signal level (dB) of each tone. A negative frequency is used to modulate the prior tone components summed together. A negative dBm level is permitted to be offset by `ipbx_tone_gain`.

ON and OFF are interleaved tone on and tone off durations in msec. A value of zero for a tone on time indicates a continuous tone. A value of zero for a tone off time produces silence while a negative value (-1) terminates the tone pattern removing the silencing. (With silencing, the voice channel is blocked until the tone pattern is stopped.)

GAI-TRONICS

Possible values for frequency are between 0-3000Hz. Possible values for dB levels are between -1 to -40 dB. The maximum number of tones is 4. The maximum number of on and off times counted individually is 9.

For example, the default setting for initial dial tone (UK and US) is **2 0 0 350 -19 400 -19**. "2" is the number of tones. Because this is a positive number, it specifies that the 2 tones are played simultaneously as opposed to in sequence. The first "0" is the number of on and off transitions in the tone pattern, which means that it is a constant tone. The second "0" causes the tone to play until otherwise instructed. The first tone is "350 -19", meaning that the tone is 350Hz with a level of -19dB. The second tone is "440 -19" meaning that the second tone is 440Hz with a level of -19dB. Because the tone is continuous, no ON or OFF times are required. The result is a constant tone consisting of 350Hz and 400Hz combined together, which plays until the phone changes state.

4.6 Status Page

The Status page has a structure of 4 sub-pages of view-only information about the phone

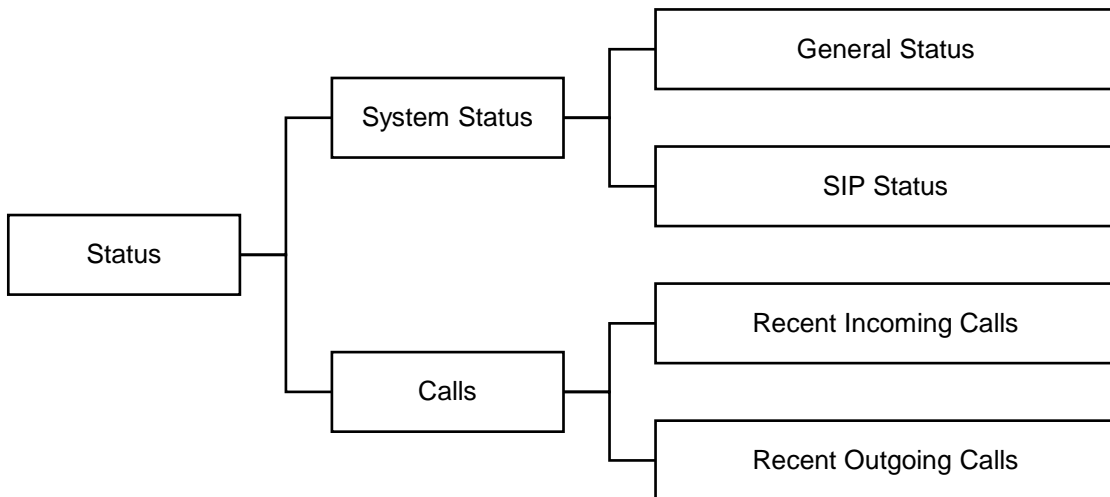

4.6.1 System Status

4.6.1.1 General status

This page shows general information such as the current IP address, gateway, DNS addresses etc as well as DHCP information. This page displays a field named "net current host name". This is factory assigned, is unique to each telephone and is used by some DHCP servers.

4.6.1.2 SIP status

This shows current SIP information including the currently selected codec and the current state of any call.

4.6.2 Calls

These two sub-pages show recent incoming and outgoing calls, timestamped with the latest at the top, together with connection information and call duration.

5. Server Failover

The telephone can maintain up to 4 VoIP accounts, each account holding a full set of credentials allowing registration and calls using different servers for redundancy purposes.

GAI-TRONICS

If the phone is unable to register or make a call it can fail over to the next account in a prioritised sequence. The accounts are organised in priority order such that VoIP account 1 is the highest priority.

There is also a parameter named voip multiple registration mode which sets whether multiple proxies and registrars are used serially or concurrently. If enabled, the telephone will attempt to maintain registration with all enabled registrars, and will use the priority sequence for outbound call failover. If disabled, the phone will attempt to register with the highest priority registrar available, either if registration fails or when the registration timer expires.

6. Audio Path Testing (APT)

The telephone can perform acoustic path testing by playing a sound from its earpiece or speaker and testing whether it can be received correctly by the microphone.

This test verifies that both mic and speaker are functioning.

Testing can be triggered manually or scheduled at regular intervals.

All the controlling parameters are on the Acoustic Path Test web page and the parameter names all start with "apt_".

The result of the test is displayed on the Acoustic Path Test web page. If the test fails it is logged as a fault both on the fault log page and via SNMP trap (see sections 9 & 10).

To initiate a test manually set apt now to "enable" and save. The test will be carried out once and apt now will return to showing disabled. The parameter "apt enabled" does not need to be enabled for a manual test.

To schedule periodic testing, set apt enable to "enable". Once enabled, the telephone will perform an acoustic path test starting at "apt time" and repeating every "apt interval" hours indefinitely. To run a test every 6 hours starting at 11pm, set apt time to "23:00:00" and apt interval to 6.

The actual test consists of tones at a set level and a range of frequencies. The phone plays the tones from its speaker or earpiece and listens to them through its microphone. It compares the received audio with the ambient noise when no tone is playing and checks that the difference lies between 2 thresholds in order to consider the test a pass

The phone can be set to run multiple tests each time, and to consider the whole test a pass if at least a minimum number of individual tests pass. For example it could be set to run 5 tests and report a pass if 3 or more out of 5 pass. This feature can be useful in areas where ambient noise levels vary considerably causing an individual test to fail spuriously. The number of individual test to run at each instance is "apt count" and the number of those individual test which need to pass in order to consider the whole to have passed is "apt ok count"

The default parameters have been found to give optimum results in most cases, on both handset and handsfree versions of telephone, but the following parameters are available (at advanced level) if they need to be adjusted for unusual conditions:

- Apt low threshold - the difference between tone and silence must exceed this to pass. Units are not defined.
- Apt high threshold - the difference between tone and silence must be below this to pass. Units are not defined.
- Apt frequency – the centre frequency of tones used. Units are not defined.
- Apt frequency band – the bandwidth of frequencies used. Units are not defined.
- Apt output level – the level at which test tones are played. Units are not defined.

Various diagnostic information, (some at advanced level), is also shown on the webpage which can be helpful to diagnose any issues with APT especially in unusual acoustic environments:

- Apt status shows the current test status, whether running or stopped.
- Apt last test date shows the date and time of the last test conducted (based on the settings on the date/time page).

GAI-TRONICS

- apt last test count shows the number of individual tests carried out the last time a test was run
- apt last test ok count shows the value of apt test ok count the last time a test was run
- apt last test passed count shows how many individual tests passed the last time a test was run
- apt last test failed count shows how many individual tests failed the last time a test was run
- apt last test result shows the overall result of the last test
- apt last test silence shows the measured ambient noise level of the last test
- apt last test tone shows the received level of the last test tone
- apt last test difference shows the difference between the last test tone and ambient noise levels
- apt last test low threshold shows the low threshold used for the last test
- apt last test high threshold shows the high threshold used for the last test

7. Features on the main 1193 PCB

The main 1193 VoIP PCB has 2 pushbuttons, 4 LEDs and a USB socket which can be used for various diagnostic and reset actions. The Auteldac 6 (1201 PCB) does not include any of these features.

Note that on some telephone models (notably Titan and Help Point), a cover may need to be removed to access the buttons.

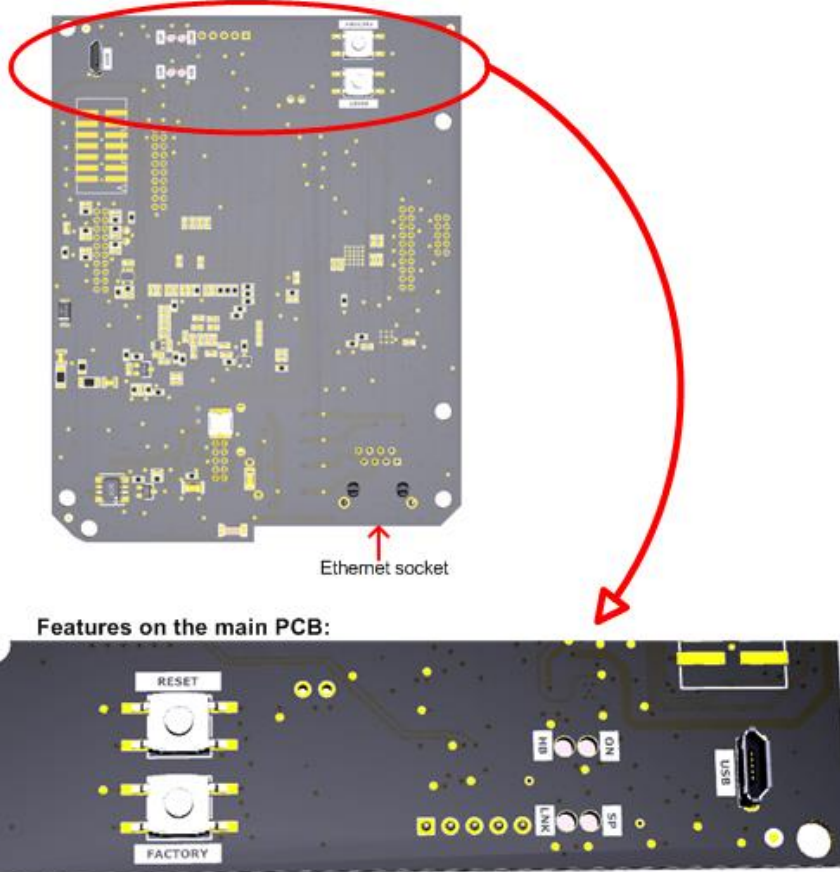

7.1 Reset button

Pressing this button momentarily will cause the unit to perform a warm reboot. Equivalent to pressing the “Reboot” button on a webpage. Note that this feature is not available on the 1201 Auteldac 6 PCB.

7.2 Factory Restore button

This button can be used to restore a telephone to its factory settings as follows:

- First press and release the Reset button to instigate a reboot.

GAI-TRONICS

- Within 5 seconds of releasing the Reset button (ie whilst the reboot is in progress), press and hold the “Factory” button for at least 10 seconds.
- The telephone will then reboot once more and be restored to its original configuration. Note that any settings or changes made via webpages or configuration upload will be lost.

Note that this feature is not available on the 1201 Auteldac 6 PCB. See section 12 for the factory restore procedure on Auteldac 6.

7.3 LEDs

The 4 LEDs on the PCB are:

- ON - indicates the board has power applied. Should be constantly on.
- HB - heartbeat - flashes slowly (approx. 800ms on, 800ms off) once the board had successfully booted up. Indicates that the firmware is running.
- LNK - Link - indicates that Ethernet is connected. This LED will flash irregularly indicating Ethernet activity
- SP - speed - when Ethernet is connected this indicates the speed - on for 100Mbps, off for 10Mbps

Note that this feature is not available on the 1201 Auteldac 6 PCB.

7.4 USB connection

A USB connection can be made to a PC for diagnostic purposes. To use the USB connection, the PC must have the correct FDTI driver installed - visit www.fdtichip.com for the latest virtual COM port (VCP) driver. Connection is made using a serial terminal program such as PuTTY, using a speed of 115200bps. Make sure the correct COM port is selected. A different COM port number could be assigned every time a different telephone is connected to the same PC. Check the PC's Device Manager to be sure.

Once connected, diagnostic information will be displayed at various stages in the phone's operation, particularly at startup or reboot. The telephone will show its MAC ID and current IP address which may prove useful in accessing the device, for example if these have been lost. Other information will also be displayed, but this will normally only be useful to GAI-Tronics technical support personnel.

This information does not require a login.

Note that this feature is not available on the 1201 Auteldac 6 PCB.

8. Remote update

GAI-Tronics VoIP telephones can be updated by downloading files from a server. This provides a powerful method of updating and maintaining multiple units across a network. Security features are built in to reduce the possibility of accidental or malicious damage. Three components of the unit's software can be upgraded:

- The configuration (equivalent to the settings on the web pages)
- The firmware code
- The boot file (used by the telephone to load the firmware at start-up)

The configuration and code files can be downloaded independently but the bootfile must always be accompanied by the code file.

The update process uses an update control file, which contains the names and version numbers of the various components, together with the server location to download them from.

The telephone always downloads and checks this small file first to see if the version numbers differ from those already loaded in the phone. The telephone only downloads a new configuration or firmware version if a version number is different.

The telephone can be set to check the update control file on a periodic basis and/or on demand. The periods can be set independently for configuration and firmware/boot file. Multiple phones can check the same update control file if required.

8.1 Structure of files used in the update process

8.1.1 Update control file

The update control file is a plain text file containing a maximum of 7 lines (not including comments).

Comments are lines starting with #.

A typical file could be:

```
# Upgrade Titan telephones to v 2.1.00
server=192.168.9.253
bootfile=1193boot1_0.ece
bootrevision=1.00.00
codefile=1193code2_1.ece
coderevision=2.01.00
cfgfile=900-20-6612.cfg
cfgrevision=1.00.00
```

Where:

Server is the IP address or FQDN of the TFTP server hosting the files to be downloaded.

Note that this allows redirection - it need not necessarily be the same server as that containing the update control file itself.

Bootfile, **codefile**, and **cfgfile** are the filenames to download from the TFTP server

Bootrevision, **coderevision** and **cfgrevision** are the version numbers of the respective files, which the telephone will check to determine whether an update is required (thereby avoiding repeated downloads). A file will only be downloaded if the version number in the control file does not match the corresponding version number currently in the telephone (shown on the System Identification page). **Cfgrevision** should have a maximum length of 15 characters - only the first 15 characters will be matched against the parameter held in the phone.

It is not necessary to list all 3 files - in other words if only the configuration is to be updated then the bootfile and code file need not be listed in the control file, but if a file is to be updated then its revision number must be included.

NOTE - the control file must always have a **blank line** at the end, to ensure that the file is read correctly

8.1.2 Configuration file

The configuration file is a plain text file containing a list of parameters and optional comments.

The configuration file is constructed as follows:

- A configuration file may contain any number of parameters and comments.
- Each parameter or comment must be on its own line.
- Comments are lines starting with #.
- Each parameter has 3 elements, combined together on a single line with no spaces or other delimiters between them:
 - The parameter name
 - The web page permission string
 - The value to assign.
- Parameters may be listed in any order.
- The telephone processes the file from top to bottom, meaning that, if a parameter is repeated in the file, the telephone will use the last setting it finds.
- **IMPORTANT** - the file must always have a **blank line** at the end, to ensure that it is read correctly

Parameters are listed in the configuration parameter descriptions in section 4.4 of this manual. Note that these are case-sensitive and must be typed exactly as they appear in section 4.4.

GAI-TRONICS

The web page permission string is one of the following values:

Permission	Basic level	Advanced level
User view only	&3e0	&23e0
User edit	&3f0	&23f0

The value to assign is preceded by an equal sign (“=”). If the value is a text string it is entered exactly as intended, including any spaces, and without any delimiters or quote marks. For logical values, “enabled” is assigned as 1, “disabled” as 0.

Example

To set the SIP display name for VoIP account 1 to be “John Smith”, and to make it user editable at advanced level, the configuration file parameter line would be:

```
_voip_provider_1.display_name&23f0=John Smith
```

8.1.3 Firmware and boot files

These are encrypted binary files which can only be provided by GAI-Tronics. The latest released versions are usually available on our website. Note that the version numbers entered in the update control file must accurately match the version numbers published for the files to prevent repeated downloading.

8.2 TFTP update process

The update process is as follows:

1. Ensure a TFTP server is available, accessible to the telephone, holding the file(s) for the telephone to download (configuration, firmware code, bootfile)
2. Ensure a TFTP server is available, accessible to the telephone, for the update control file. This can be the same server as used for the download file(s) if required.
3. Ensure that the update control file is constructed as described above
4. Enter the name of the update control file into the phone update control file field on the Update Parameters page
5. Enter the address of the TFTP server phone into the update domain name field on the Update Parameters page
6. Ensure that other update parameters are correctly set on the Update Parameters page. Note that there are two sets of parameters, one for configuration updates and another set for firmware updates, so that these can be managed separately if required. Bootfile updates are controlled by the firmware update parameters. There is however only one update control file - both sets of parameters use a common update control file.
7. Updates are initiated by the telephone. The telephone can be set to check for updates upon reset, and/or periodically, or to perform an update on manual command. There is a facility to add a random delay to periodic updates to avoid network congestion if large numbers of telephones all attempt to update at the same time. To initiate a manual update, set one or both of the “Update now” buttons to “enable” and click the Update button. The telephone will perform the update(s) and the “update now” button(s) will revert to “disable”.
8. Status messages for the update process (sent on request, success or failure) can be sent via Syslog, provided a suitable Syslog server has been configured on the Phone maintenance page.

GAI-TRONICS

8.2.1 TFTP Upgrade Example

This is an example showing a firmware update. In this example the phone is 192.168.9.3, and the TFTP server is 192.168.9.128.

1. Copy the firmware files onto the TFTP server and add the control file. In this example the update control file is called update1193.txt.

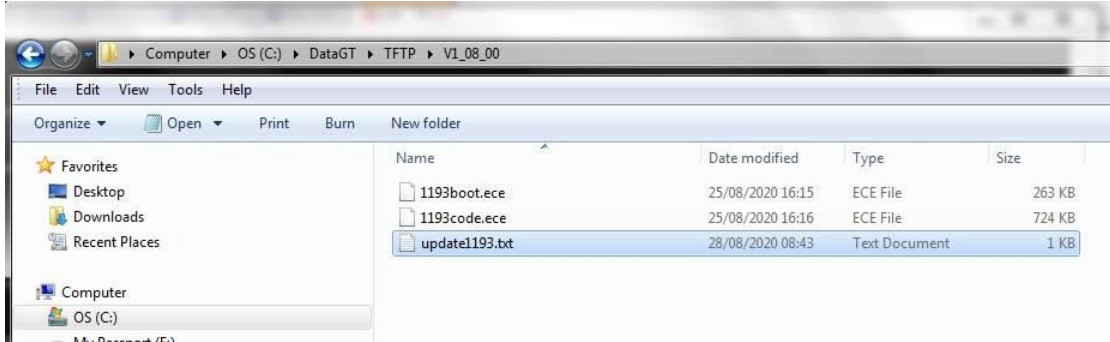

2. The contents of the update control file are shown below. Note the versions contained in this file are what the phone will display on the System Identification page when it is updated e.g. 1.08.00

```
# update to v1.08
server=192.168.9.128
bootfile=1193boot.ece
bootrevision=1.08.00
codefile=1193code.ece
coderevision=1.08.00
```

3. Point the TFTP server at the directory with the files. This example is using Tftpd32 as the TFTP server.

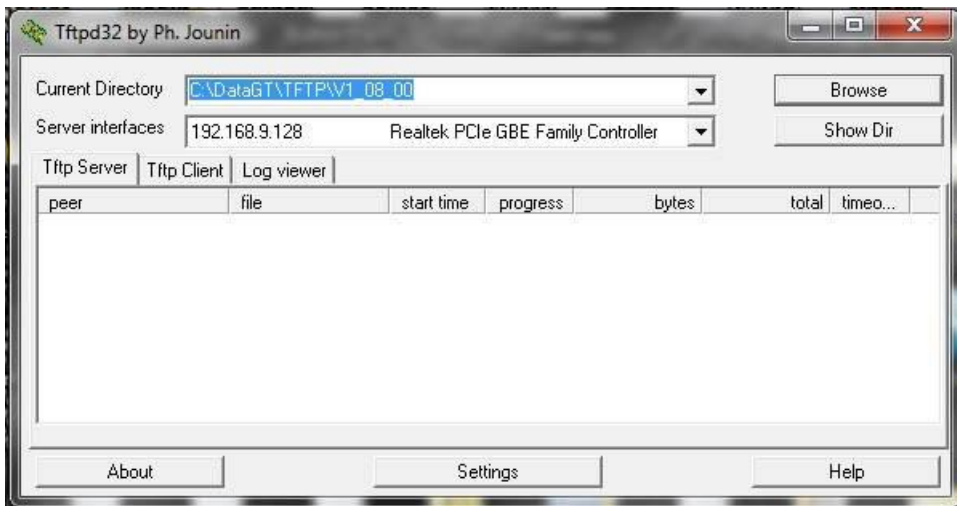

4. Check the current boot rom revision and firmware revision. These must be different from what we have in the control file. In this example the phone currently has 01.00.31

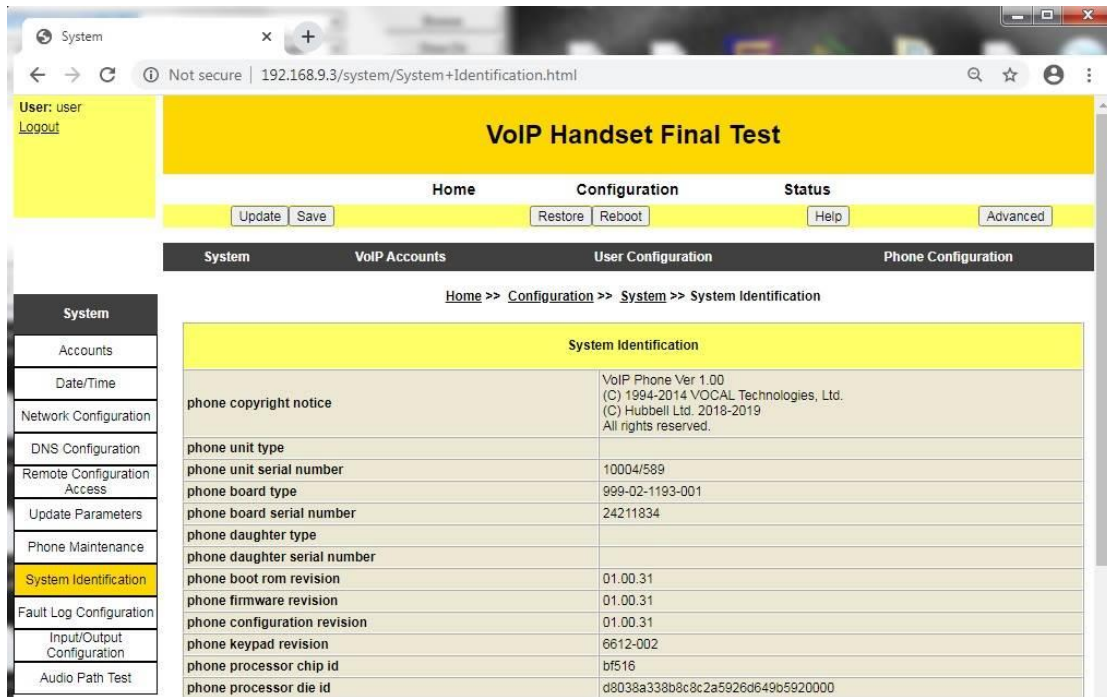

- Set the update parameters to use the TFTP server. Set update domain name to the server address, firmware update enable, firmware update now. Then press update.

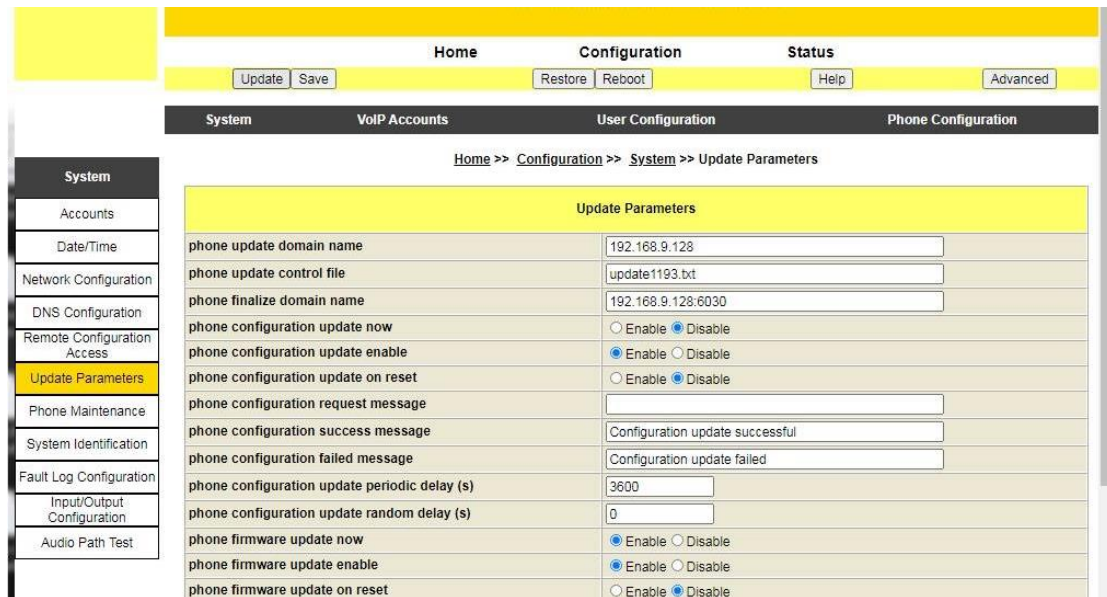

- Check the TFTP server to prove that it has downloaded the control file and then the firmware files. Note the firmware versions in the phone and those listed in the control file must be different for the phone to download the firmware.

GAI-TRONICS

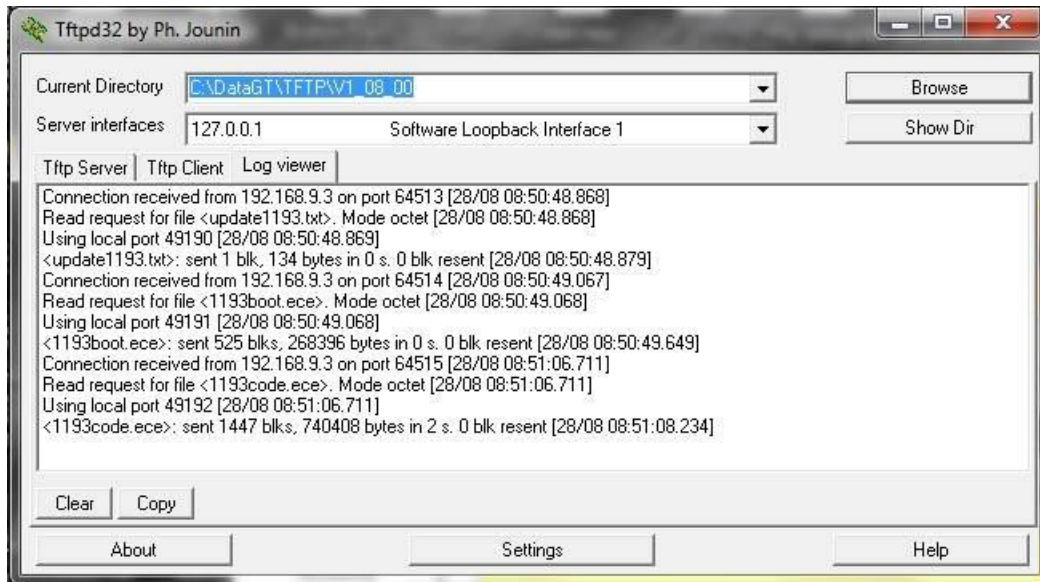

7. Check the firmware version has changed. Now shows 1.08.00.
8. Note that the phone copyright notice (at the top of the System Identification page) shows the actual current version of the firmware, regardless of what was in the update control file.

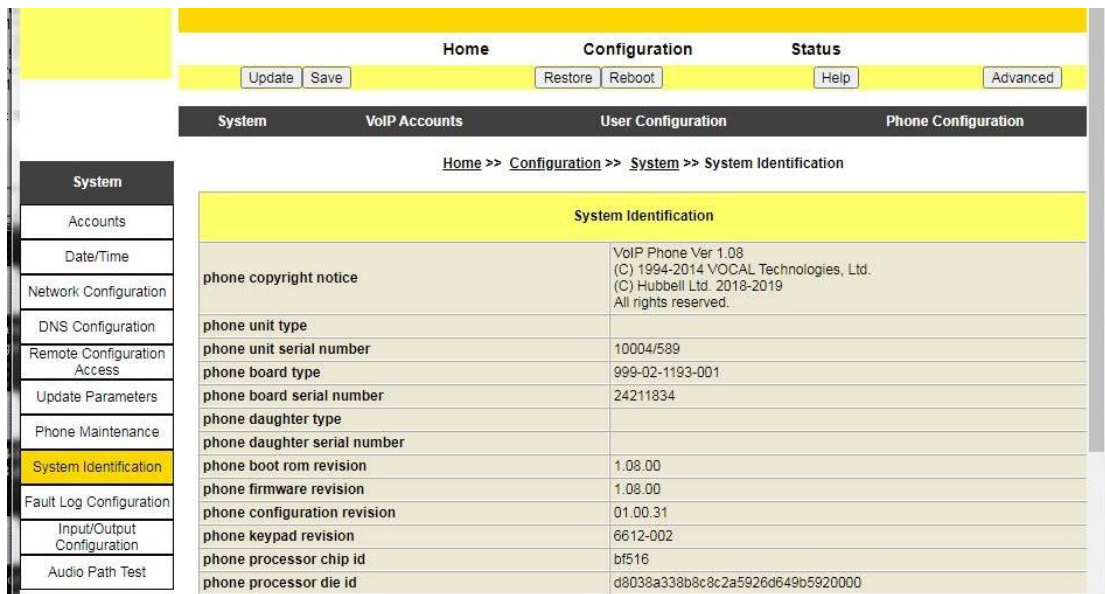

9. SNMP

The telephone includes an SNMP client and server (SNMPv2) for maintenance and reporting. Maintenance means the ability to read and change parameters via an integral SNMP server. Reporting means the sending of SNMP traps to a remote server.

9.1 General SNMP set up

To use SNMP, the following parameters must be set (on the Phone Maintenance page) and changed from their default settings where appropriate:

- Snmp server enable -> enabled (this parameter is disabled by default)
- Snmp community 1
- Snmp community 1 access

GAI-TRONICS

- Snmp community 2
- Snmp community 2 access
- Snmp trap enable -> enabled (this parameter is disabled by default)
- Snmp trap server (to be the IP address of the remote server receiving SNMP traps)
- Snmp trap community

9.2 Maintenance

Maintenance requires the use of the correct MIB file. Make sure the correct version of MIB is used – the MIB will usually be related to a specific version of firmware. MIB files are published on our website together with which version(s) of firmware they are applicable to. The MIB tree follows the web page structure as described in section 4, and the parameter names are the same as those used on the web pages.

Any parameter that can be viewed on the web pages can be read using a GET command in SNMP. Any parameter that can be edited on the web pages can be set using a SET command in SNMP.

Note – any changes made need to be saved using the systemConfigAndSave parameter in the systemSave section of the MIB tree, otherwise the changes will be lost.

9.3 SNMP Traps

SNMP traps are sent for faults and events generated by the telephone.

Fault traps are the same as those listed in section 10, ie

Fault description	Trap code
fault_sip_provider0_reg_failed	1
fault_sip_provider1_reg_failed	2
fault_sip_provider2_reg_failed	3
fault_sip_provider3_reg_failed	4
fault_loop_detected	8
fault_off_hook_idle_timeout	10
fault_configuration_error	11
fault_keyboard_error	13
fault_audio_path_test_failure	14
fault_power_interruption	16
fault_fault_log_full	17

In addition, the following event traps are sent:

Event description	Trap code
Audio path test pass	15
Input1 On	21
Input1 Off	22
Input2 On	23
Input2 Off	24
Input3 On	25
Input3 Off	26
Input4 On	27
Input4 Off	28
On Hook	29
Off Hook	30

Traps are UDP, sent via port 162.

10. Fault reporting (via SNMP and / or FTP)

The telephone can self-diagnose various faults and report them using a number of methods:

- Web page
- Fault log (sent via FTP – see below)
- SNMP (see section 9), or

GAI-TRONICS

- TMA (see section 11)

The faults reported are the same for all methods.

The web page (Fault Log Configuration) shows a fault status mask and a fault clear mask. The fault status mask is a text representation of an 8-digit hex number, where each digit can be between 0 and f, representing the state of up to 4 fault sensors.

If no faults have occurred, the fault mask will be 00000000

If any faults have occurred, the fault mask will show a value made by adding the hex values of the faults shown below.

Only the fault sensors below are currently defined.

Not all fault sensors are present in all models of telephone.

Faults greyed out in the table below are reserved for future use

Fault description	Description	Hex code
fault_sip_provider0_reg_failed	Registration failure	0x00000001
fault_sip_provider1_reg_failed	Registration failure	0x00000002
fault_sip_provider2_reg_failed	Registration failure	0x00000004
fault_sip_provider3_reg_failed	Registration failure	0x00000008
fault_low_battery		0x00000010
fault_transducer_1		0x00000020
fault_transducer_2		0x00000040
fault_loop_detected	Handset integrity loop broken	0x00000080
fault_proximity_detected		0x00000100
fault_off_hook_idle_timeout	Phone left off hook exceeding timeout	0x00000200
fault_configuration_error	Configuration error	0x00000400
fault_peripheral_init_failure		0x00000800
fault_keyboard_error	Stuck button	0x00001000
fault_audio_path_test_failure	APT fail	0x00002000
fault_battery_charge_failure		0x00004000
fault_power_interruption	Cold reset	0x00008000
fault_fault_log_full	Fault log overflow	0x00010000
fault_network_ring_failure_cw		0x00020000
fault_network_ring_failure_ccw		0x00040000

Example, if a telephone had a keyboard error and an audio path test failure, the fault mask would be 00003000.

Fault indications “stick” on the web page and in the SNMP tree – The only way to CLEAR a fault from the fault mask is by manually entering the fault code for the fault then updating, either via the web page or SNMP. In this way the phone will record that a fault has occurred even if it has subsequently self-cleared.

If valid credentials for an FTP server are entered in the fault log configuration sections, a log file will be sent every time a fault occurs or if the “send fault log now” button is enabled and the page updated. The fault log file is a plain text file, using the fault codes from the table above.

11. TMA

GAI-Tronics TMA is a fully featured software application (Telephone Management Application) for Windows®, offering the facilities to program, maintain, monitor and report on all types of GAI-Tronics VoIP, GSM and SMART analogue products.

In order for these VoIP telephones to communicate with TMA, the following parameters need to be set appropriately:

- On the Remote Configuration Access page:
 - phone telnet server enable – enabled
- On the Phone Maintenance page:
 - net syslog enable - enabled
 - net syslog server – set to the IP address of the TMA PC
 - net syslog server port – set to 514

GAI-TRONICS

- net syslog facility set to 14
- net syslog severity set to 5

To use the links within TMA to manage phone settings (if required), the phone web external server enable parameter (on the Remote Configuration Access page) must also be enabled with phone web server port set to 80.

12. Restore to Factory defaults

With the exception of Auteldac 6, if the IP address is not known, it can be discovered by making a USB connection as described in section 7.4 above.

The telephone can be restored to its factory defaults (ie to the configuration it had when first delivered) as follows:

- **Auteldac 6:**
 - Power off the phone
 - Press & hold the **M3 & *** buttons
 - Power on the phone whilst keeping both buttons pressed
 - After 15 seconds, release the buttons
 - The phone will now load the factory default configuration and then boot up.
- **All other models:** by using the FACTORY button on the main PCB, as described in section 7.2 above.

13. Copyright Notices

© Hubbell Ltd., 2018-2020. All rights reserved.

The software within the product includes parts subject to other copyright as follows:

Cryptographic software copyright © 1995-1998 Eric Young (eay@cryptsoft.com)
All rights reserved.

Redistribution and use in source and binary forms, with or without modification, are permitted provided that the following conditions are met:

1. Redistributions of source code must retain the copyright notice, this list of conditions and the following disclaimer.
2. Redistributions in binary form must reproduce the above copyright notice, this list of conditions and the following disclaimer in the documentation and/or other materials provided with the distribution.
3. All advertising materials mentioning features or use of this software must display the following acknowledgement:

"This product includes cryptographic software written by
Eric Young (eay@cryptsoft.com)"

The word 'cryptographic' can be left out if the routines from the library being used are not cryptographic related :-).

4. If you include any Windows specific code (or a derivative thereof) from the apps directory (application code) you must include an acknowledgement:
"This product includes software written by Tim Hudson (tjh@cryptsoft.com)"

THIS SOFTWARE IS PROVIDED BY ERIC YOUNG ``AS IS'' AND ANY EXPRESS OR IMPLIED WARRANTIES, INCLUDING, BUT NOT LIMITED TO, THE IMPLIED WARRANTIES OF MERCHANTABILITY AND FITNESS FOR A PARTICULAR PURPOSE ARE DISCLAIMED. IN NO EVENT SHALL THE AUTHOR OR CONTRIBUTORS BE LIABLE FOR ANY DIRECT, INDIRECT, INCIDENTAL, SPECIAL, EXEMPLARY, OR CONSEQUENTIAL DAMAGES (INCLUDING, BUT NOT LIMITED TO, PROCUREMENT OF SUBSTITUTE GOODS OR SERVICES; LOSS OF USE, DATA, OR PROFITS; OR BUSINESS INTERRUPTION) HOWEVER CAUSED AND ON ANY THEORY OF LIABILITY, WHETHER IN CONTRACT, STRICT LIABILITY, OR TORT (INCLUDING NEGLIGENCE OR OTHERWISE) ARISING IN ANY WAY OUT OF THE USE OF THIS SOFTWARE, EVEN IF ADVISED OF THE POSSIBILITY OF SUCH DAMAGE.

The licence and distribution terms for any publically available version or derivative of this code cannot be changed. i.e. this code cannot simply be copied and put under another distribution licence

GAI-TRONICS

[including the GNU Public Licence.]

SNMP Copyright 1988, 1989 by Carnegie Mellon University
All Rights Reserved

Permission to use, copy, modify, and distribute this software and its documentation for any purpose and without fee is hereby granted, provided that the above copyright notice appear in all copies and that both that copyright notice and this permission notice appear in supporting documentation, and that the name of CMU not be used in advertising or publicity pertaining to distribution of the software without specific, written prior permission.

CMU DISCLAIMS ALL WARRANTIES WITH REGARD TO THIS SOFTWARE, INCLUDING ALL IMPLIED WARRANTIES OF MERCHANTABILITY AND FITNESS, IN NO EVENT SHALL CMU BE LIABLE FOR ANY SPECIAL, INDIRECT OR CONSEQUENTIAL DAMAGES OR ANY DAMAGES WHATSOEVER RESULTING FROM LOSS OF USE, DATA OR PROFITS, WHETHER IN AN ACTION OF CONTRACT, NEGLIGENCE OR OTHER TORTIOUS ACTION, ARISING OUT OF OR IN CONNECTION WITH THE USE OR PERFORMANCE OF THIS SOFTWARE.